

# SG 3840

---

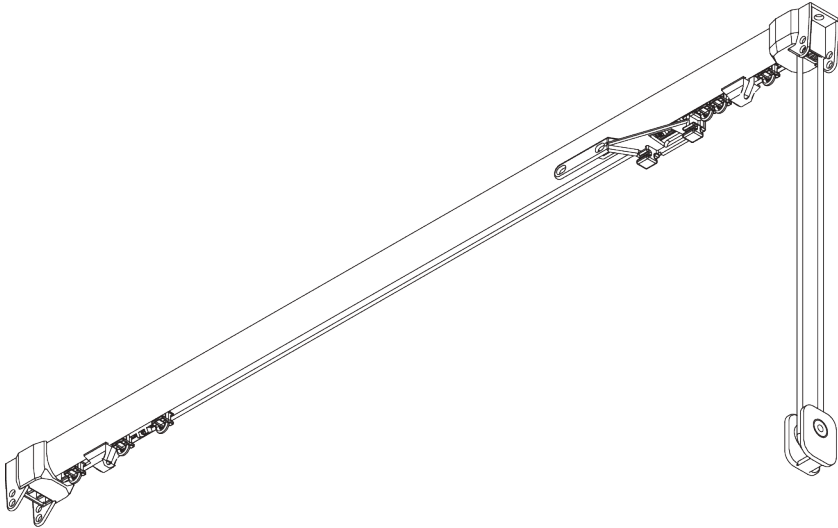
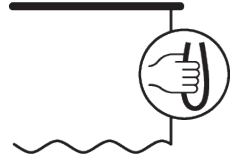

## PRODUCT INFORMATION

- **Operation:** cord
- **Range:** M - L
- **Fitting:** ceiling, wall
- **Colours:** white RAL 9016; special colours or anodised aluminum possible
- **Fabrics:** refer to Silent Gliss fabric collection

### **Features:**

- 2-component (2C) glider technology
- Wave (2C)
- Bendable

# SYSTEM SPECIFICATIONS

## A. SYSTEM DIMENSIONS

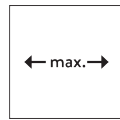

6 m



14 kg

### Max. curtain weight - 2C glider or roller

	2 m	4 m	6 m
	12	11	10
	14	13	12
	9	8	7
	10	9	6
	6	5	4
	7	6	5
	5	4	3
	6	5	4

(kg max.)

### Max. curtain weight - Wave 2C glider cord

	2 m	4 m	6 m
	5	8	7
	5	8	8
	5	6	5
	5	6	6
	4	3	-
	4	4	3
	3	2	-
	3	3	-

(kg max.)

## B. PROFILE

### Profile and bending information

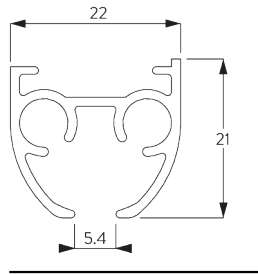

**SG 3841**

Profile

Radius:  
20 cm, >30 cm

### C. HOW TO MEASURE

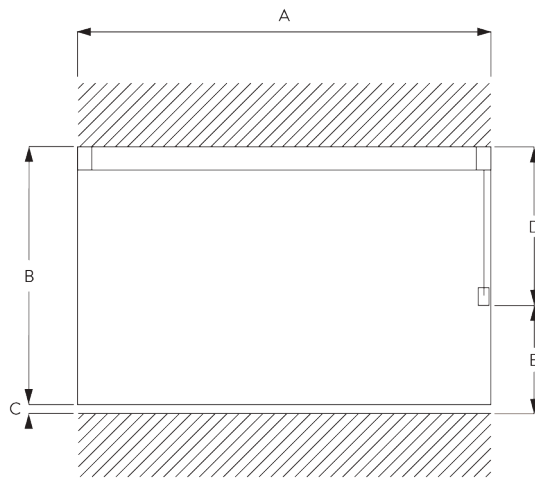

- A: System width
- B: System height
- C: Distance between floor and fabric
- D: Cord height
- E: Safety Retainer SG 10731 min. 150 cm above floor

### D. SPECIFICATION

TEXT

**Silent Gliss SG 3840 Cord Operated Curtain Track System.** Comprising aluminium profile SG 3841 supplied made to measure in silver anodised or powder coated in white / matt white / anodic grey / antique bronze / charcoal. Supplied as standard with 2C gliders SG 11300 at 14/m, cord guide/return set SG 3845, pilot runner SG 3842/3, overlap SG 6288 and cord SG 3090. Top fixed with fixing clamp SG 3825 at max. 500mm centres. Optional top fix bracket SG 3826 / SG 3832. Wall fix with nylon bracket 3836 / SG Smart Fix brackets SG 11200-11205 / SG Square Smart Fix brackets 11210 – 11215 / SG Universal Smart Fix brackets SG 11154 -11156 with either SG 3832 or SG 3826 brackets . Silent Gliss Wave option is available using 60mm glider cord 11303 / 80mm glider cord 11302. Compliant to Child Safety legislation EN 13120.

# FITTING

### A. FITTING INFORMATION

For detailed fitting information, visit the Silent Gliss website.

#### Fixing Points

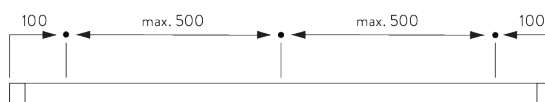

**B. CEILING FITTING**

**Clamp SG 3825**

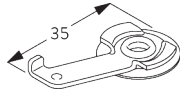
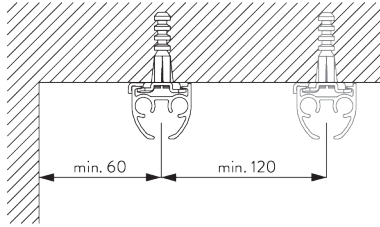

**SG 3825**

*Clamp*

**Bracket SG 3832**

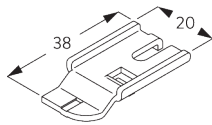
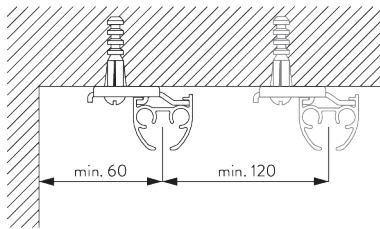

**SG 3832**

*Bracket*

**Bracket SG 3826**

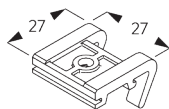
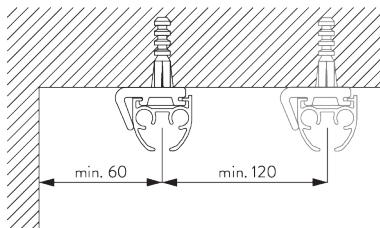

**SG 3826**

*Bracket*

## C. WALL FITTING

### Smart Fix

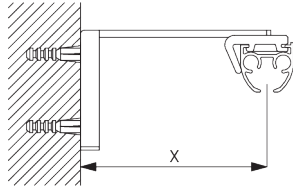

**Smart Fix SG 11200 - SG 11205 and bracket SG 3826:**  
Screw SG 10492 (M4x8) needed.

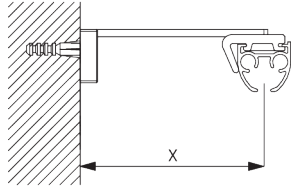

**Square Smart Fix SG 11210 - SG 11215 and bracket SG 3826:**  
Screw SG 10492 (M4x8) needed.

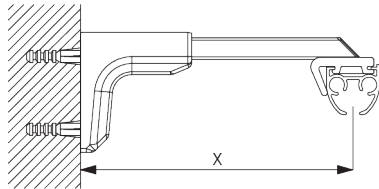

**Universal Smart Fix SG 11154 - SG 11156 and bracket SG 3826:**  
Screw SG 10277 (M4x12) needed.

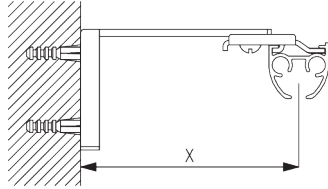

**Smart Fix SG 11200 - SG 11205 and bracket SG 3832:**  
Screw SG 10492 (M4x8) needed.

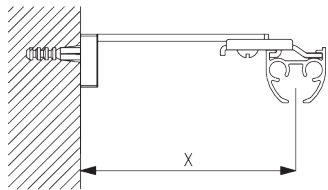

**Square Smart Fix SG 11210 - SG 11215 and bracket SG 3832:**  
Screw SG 10492 (M4x8) needed.

Smart Fix	X mm (SG 3826 / SG 3825)	X mm (SG 3832)
SG 11200 / SG 11210	52	70
SG 11201 / SG 11211	72	90
SG 11202 / Sg 11212	92	110
SG 11203 / SG 11213	112	130
SG 11204 / SG 11214	142	160
SG 11205 / SG 11215	192	210
SG 11154	102-130	120-148
SG 11155	132-160	150-178
SG 11156	182-210	200-228

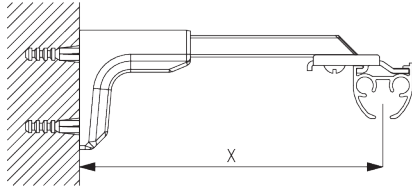

**Universal Smart Fix SG 11154 - SG 11156 and bracket SG 3832:**  
Screw SG 10407 (M4x10) needed.

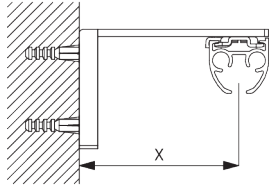

**Smart Fix SG 11200 - SG 11205 and clamp SG 3825:**  
Screw SG 10074 (M4x8) needed.

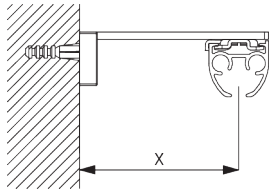

**Square Smart Fix SG 11210 - SG 11215 and clamp SG 3825:**  
Screw SG 10074 (M4x8) needed.

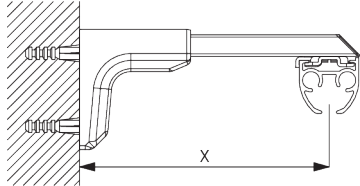

**Universal Smart Fix SG 11154 - SG 11156 and clamp SG 3825:**  
Screw SG 11158 (M4x12) needed.

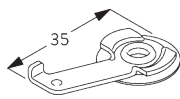

**SG 3825**  
Clamp

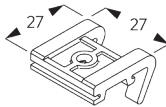

**SG 3826**  
Bracket

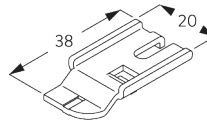

**SG 3832**  
Bracket



**SG 10074**  
Countersunk head screw  
M4x8



**SG 10277**  
Pan head screw M4x12



**SG 10407**  
Pan head screw M4x10



**SG 10492**  
Pan head screw M4x8



**SG 11158**  
Countersunk head screw  
M4x12

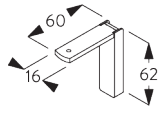

**SG 11200**  
Smart Fix 60 mm

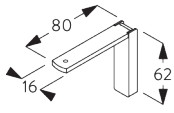

**SG 11201**  
Smart Fix 80 mm

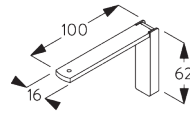

**SG 11202**  
Smart Fix 100 mm

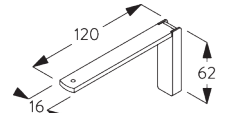

**SG 11203**  
Smart Fix 120 mm

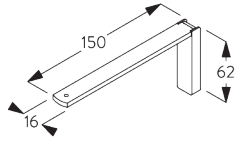

**SG 11204**  
Smart Fix 150 mm

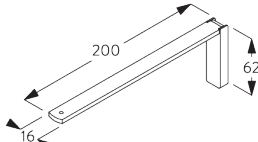

**SG 11205**  
Smart Fix 200 mm

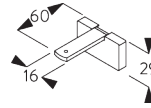

**SG 11210**  
Square Smart Fix 60 mm

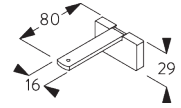

**SG 11211**  
Square Smart Fix 80 mm

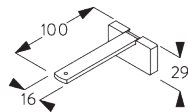

**SG 11212**  
Square Smart Fix 100 mm

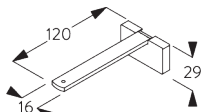

**SG 11213**  
Square Smart Fix 120 mm

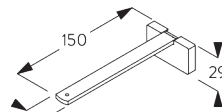

**SG 11214**  
Square Smart Fix 150 mm

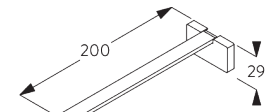

**SG 11215**  
Square Smart Fix 200 mm

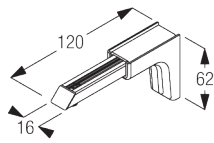

**SG 11154**  
Universal Smart Fix 120 mm

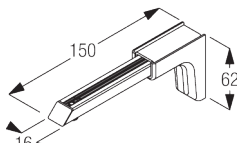

**SG 11155**  
Universal Smart Fix 150 mm

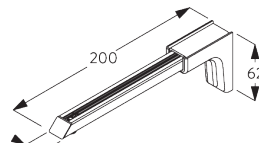

**SG 11156**  
Universal Smart Fix 200 mm

## Bracket SG 3836

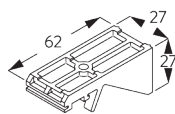
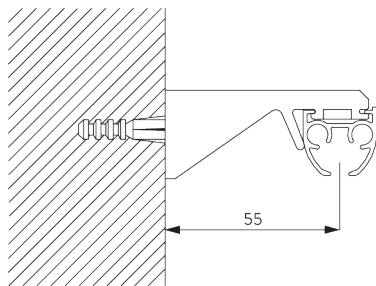

**SG 3836**  
Bracket

# SYSTEM OPTIONS

## A. WAVE

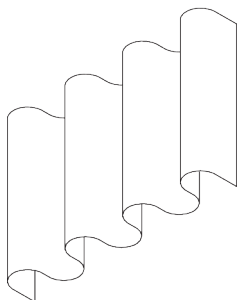

SG 11295

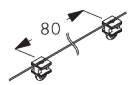

SG 11302

### Standard components:

- SG 11295 End stop
- SG 11302 Wave 2C glider cord 80 mm

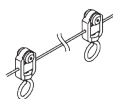

SG 6099

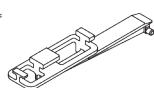

SG 6364



SG 6365

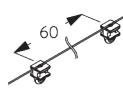

SG 11303

### Optional component (min. radius >30 cm):

- SG 6099 Wave roller cord 80 mm
- SG 6364 Wave extension
- SG 6365 Wave hanger
- SG 11303 Wave 2C glider Cord 60 mm



SG 3582

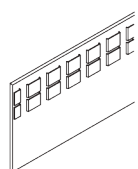

SG 6349

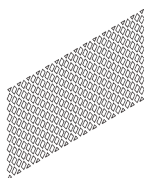

SG 6363

### Curtain components:

- SG 3582 Hook
- SG 6349 Wave curtain tape
- SG 6363 Wave top hemming tape
- SG 10075 Lead weight 50 gr/m
- SG 10076 Fabric weight



SG 10075



SG 10076



Wave stack depth - 2C glider cord (standard components)

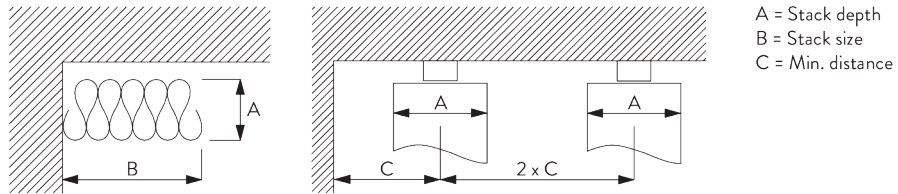

2C Glider cord SG 11302	Pockets between hooks	Approx. curtain fullness	Stack depth A	Stack size B*	Min distance C
80	6	~2.1	140	180 per metre of track	90
80	7	~2.3	160	180 per metre of track	100

2C Glider cord SG 11303	Pockets between hooks	Approx. curtain fullness	Stack depth A	Stack size B*	Min distance C
60	4	~2.1	100	230 per metre of track	70
60	5	~2.3	120	230 per metre of track	80

\*Stack size B

- Standard = plus 35 mm per curtain
- Optional extension arm SG 6364 = plus 130 mm per curtain

## GENERAL NOTES

### Dimensions

- Measurements are in mm except where indicated.
- Max. kg relates to fabric incl. accessories.
- Stack size depends on curtain make-up and fabric thickness.
- Distance between gliders max. 80 mm / distance between rollers max. 100 mm.
- Recommended distance floor / fabric: 20 mm.
- In order to determine system height (B), the smallest room height must be taken into account.
- Full functionality may be affected if the curtain touches the profile.

### Fitting







- Installation by qualified fitter only.
- Number of brackets and fitting positions / fixing points vary depending on fitting surface, system weight, fabric make-up, screw / fixing type and obstacles.
- Qualified fitter must use appropriate screws / fixings for each situation.
- Profile lip if applicable to be installed to room side.

### Child Safety





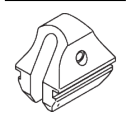

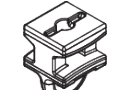



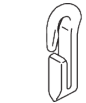
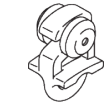

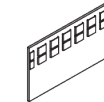

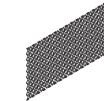
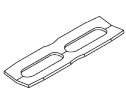
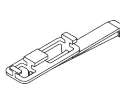
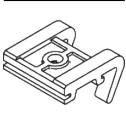
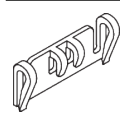
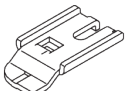

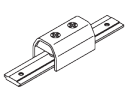
- All relevant Silent Gliss systems correspond to child safety EN 13120.
- All parties involved must comply with EN 13120.

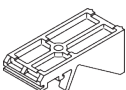
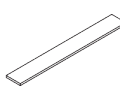
# PARTS

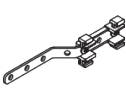
## A. STANDARD PARTS

	<b>SG 3090</b> Cord ø 3.5 mm
	<b>SG 3825</b> Clamp
	<b>SG 3841</b> Profile
	<b>SG 3845</b> Cord guide set
	<b>SG 6086</b> Spring stop
	<b>SG 6288</b> Overlap arm
	<b>SG 10731</b> Child safety retainer set
	<b>SG 11300</b> 2C glider

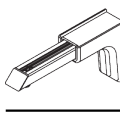
## B. OPTIONAL PARTS

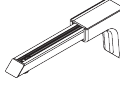
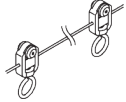
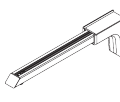
	<b>SG 3571</b> Hook		<b>SG 6283</b> Roller
	<b>SG 3582</b> Hook		<b>SG 6349</b> Wave curtain tape
	<b>SG 3599</b> Hook		<b>SG 6363</b> Wave top hemming tape
	<b>SG 3802</b> Connection bridge		<b>SG 6364</b> Wave extension
	<b>SG 3826</b> Bracket		<b>SG 6365</b> Wave hanger
	<b>SG 3832</b> Bracket		<b>SG 10074</b> Countersunk head screw M4x8
	<b>SG 3833</b> Intermediate guide		<b>SG 10075</b> Lead weight 50 g/m
	<b>SG 3836</b> Bracket		<b>SG 10076</b> Fabric weight
	<b>SG 6053</b> Spring stop		<b>SG 10277</b> Pan head screw M4x12
	<b>SG 6063</b> Overlap arm		<b>SG 10407</b> Pan head screw M4x10
	<b>SG 6064</b> End stop		<b>SG 10492</b> Pan head screw M4x8
	<b>SG 6065</b> End stop		<b>SG 11154</b> Universal Smart Fix 120 mm
	<b>SG 6094</b> Roller		<b>SG 11155</b> Universal Smart Fix 150 mm
	<b>SG 6099</b> Wave roller cord 80 mm		<b>SG 11156</b> Universal Smart Fix 200 mm

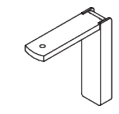

**SG 11200**  
Smart Fix 60 mm

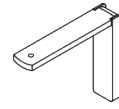

**SG 11201**  
Smart Fix 80 mm

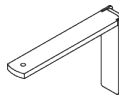

**SG 11202**  
Smart Fix 100 mm

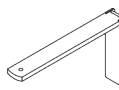

**SG 11203**  
Smart Fix 120 mm

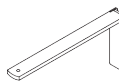

**SG 11204**  
Smart Fix 150 mm



**SG 11205**  
Smart Fix 200 mm

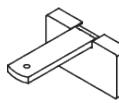

**SG 11210**  
Square Smart Fix 60 mm

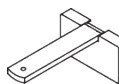

**SG 11211**  
Square Smart Fix 80 mm

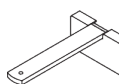

**SG 11212**  
Square Smart Fix 100 mm

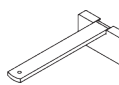

**SG 11213**  
Square Smart Fix 120 mm

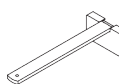

**SG 11214**  
Square Smart Fix 150 mm

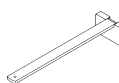

**SG 11215**  
Square Smart Fix 200 mm

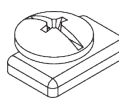

**SG 11295**  
End stop



**SG 11301**  
2C glider on strip

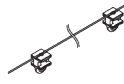

**SG 11302**  
Wave 2C glider cord 80 mm

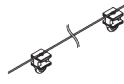

**SG 11303**  
Wave 2C glider cord 60 mm

