

SG 5600

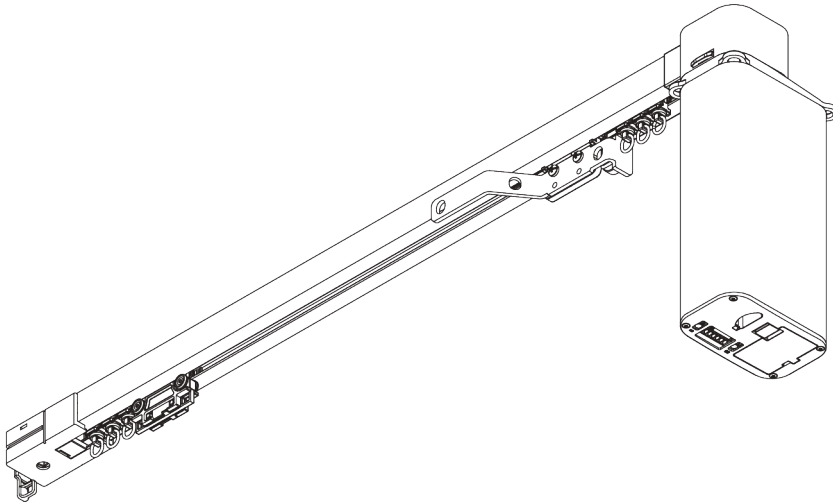
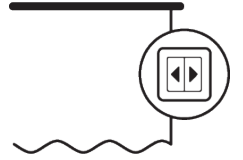

PRODUCT INFORMATION

- **Operation:** motorised
- **Range:** S - L
- **Fitting:** ceiling, wall, recess
- **Colours:** white RAL 9016 or anodised aluminum, special colours possible (recess profile only in white RAL 9016 or special color)
- **Fabrics:** refer to Silent Gliss fabric collection

Features:

- Quiet, fast and powerful motor
- 2-component (2C) roller technology
- Wave (2C)
- Various control options
- Touch & Go
- Manual override incl. permanent positioning sensor
- Easy programming
- 100-250 AC and / or 24 V DC in one motor
- Bendable
- Bendable recess profile

SYSTEM SPECIFICATIONS

A. SYSTEM DIMENSIONS

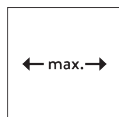

25 m

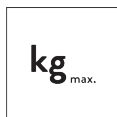

65 kg

Max. curtain weights with 2C rollers / Wave rollers

Up to 12 m: Touch & Go, manual override, auto programming mode

	2 m	4 m	6 m	8 m	10 m	12 m	15 m	18 m	21 m	25 m
	25	45	45	50	65	45	45	45	45	40
	25	45	45	50	65	45	45	45	45	40
	25	35	35	40	35	35	35	32	29	25
	25	35	35	40	35	35	35	32	29	25
	25	30	30	30	25	25	22	19	15	-
	25	30	30	30	25	25	22	19	15	-
	20	20	20	18	16	12	10	-	-	-
	20	20	20	18	16	12	10	-	-	-

(kg max.)

Max. curtain weights with Wave gliders

	2 m	4 m	6 m	8 m	10 m
	20	25	25	25	20
	20	25	25	25	20
	20	20	20	20	15
	20	20	20	20	15
	20	20	20	15	10
	20	20	20	15	10
	20	20	15	8	-
	20	20	15	8	-

(kg max.)

B. PROFILE

Profile and bending information

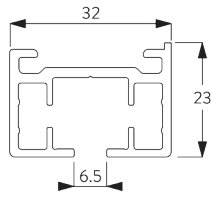

SG 10850

Profile

Radius: >25 cm

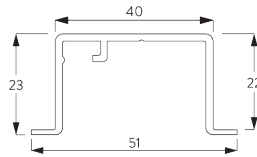

SG 10862

Recess profile

Radius: 50 - 75 cm
>75 cm on request

C. HOW TO MEASURE

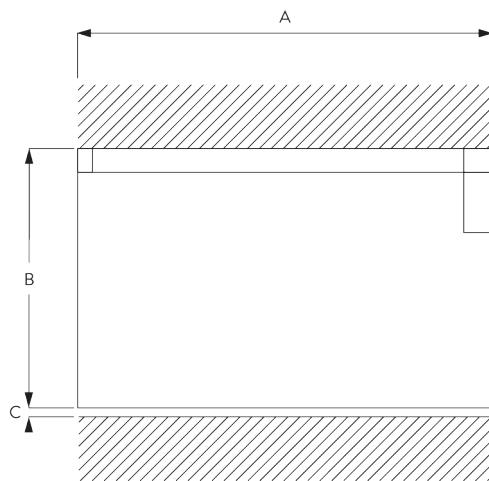

A: System width
B: System height
C: Distance between floor and fabric

D. SPECIFICATION TEXT

Silent Gliss 5600 Electrically Operated Curtain Track with Smart by Silent Gliss enabled motor. Comprises aluminium profile SG 10850 in silver anodized / white powder coated finish complete and ready assembled with interference free brushless motor SG 9060 with plug in 'Smart by Silent Gliss module SG 11270. Includes internal drive belt SG 10825, belt return set SG 10819. Supplied with 2C roller gliders SG 10840/ Wave 2C glider cord 60mm SG 10906 / Wave 2C 80mm glider cord SG 10905 / 2C Wave roller glider cord 60mm SG 10869 / 2C Wave roller glider cord 80mm SG 10852. Features manual 'Touch and Go' operation and manual override in the event of power failure. Top fixed with clamps SG 3004 at max. 500mm centres / face fixed with Silent Gliss Smart Fix extension bracket range. Optional recess profile SG 10862. Operation by compatible third-party control system offering full two-way communication. Powered by 24V DC power supply (not supplied) or mains power. Permanent memory limit switching positions. Only to be used in conjunction with associated 'Smart by Silent Gliss' Gateway and components. All wiring to be strictly in accordance with Silent Gliss wiring diagrams.

Silent Gliss 5600 Electrically Operated Curtain Track. Comprises aluminium profile SG 10850 in silver anodized /white powder coated finish complete and ready assembled with interference free brushless motor SG 9060. Includes internal drive belt SG 10825, belt return set SG 10819. Supplied with 2C roller glider SG 10840/ Wave 2C glider cord 60mm SG 10906/ Wave 2C 80mm glider cord SG 10905/2C Wave roller glider cord 60mm SG 10869/2C Wave roller glider cord 80mm SG 10852. Features manual 'Touch and Go' operation (with permanent power only) and manual override in the event of power failure. Top fixed with clamps SG 3004 at max. 500mm centre / face fixed with Silent Gliss Smart Fix extension bracket range. Optional recess profile SG 10862. Operation by mains or dry contact switching. Optional plug in receiver modules for switching by Silent Gliss radio controls System SG 0450/SG 9940. Operation via app possible using Mover Server Set SG 9960 (requires radio control module SG9063). Mains or 24v DC power supply (power supply not included). Permanent memory limit switching positions. All wiring to be strictly in accordance with Silent Gliss wiring diagrams.

FITTING

A. FITTING INFORMATION

Fixing points

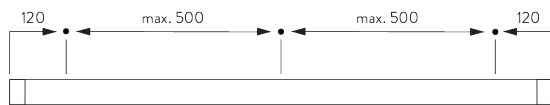

For detailed fitting information, visit the [Silent Gliss website](#).

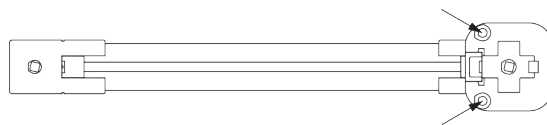

Motor holder to be fixed (ceiling fitting only).

B. CEILING FITTING

Clamp SG 3004

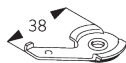
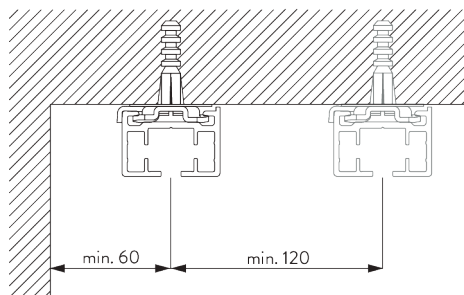

SG 3004
Clamp

Direct fitting (2C roller only)

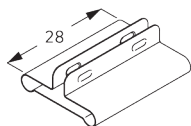
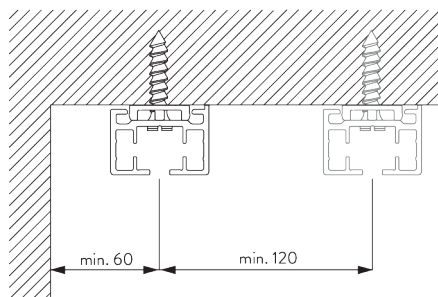

SG 7002
Profile protector

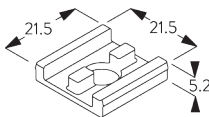

SG 10865
Support plate

C. WALL FITTING

Smart Fix

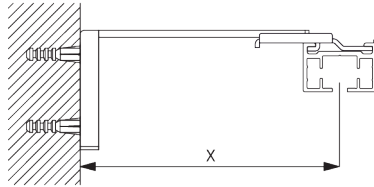

Smart Fix SG 11200 - SG 11205 and bracket SG 3041:
Screw SG 10492 (M4x8) needed.

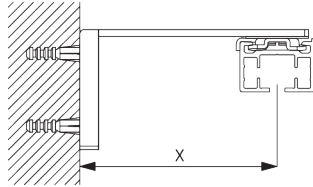

Smart Fix SG 11200 - SG 11205 and clamp SG 3004:
Screw SG 10074 (M4x8) needed.

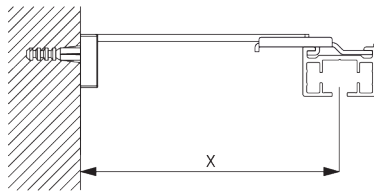

Square Smart Fix SG 11210 - SG 11215 and bracket SG 3041:
Screw SG 10492 (M4x8) needed.

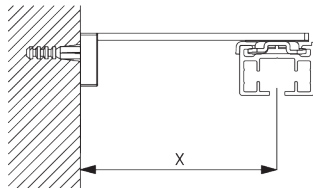

Square Smart Fix SG 11210 - SG 11215 and clamp SG 3004:
Screw SG 10074 (M4x8) needed.

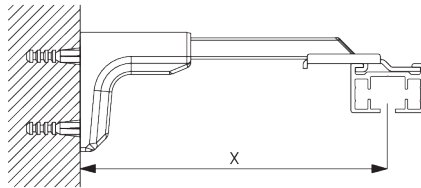

Universal Smart Fix SG 11154 - SG 11156 and bracket SG 3041:
Screw SG 10407 (M4x10) needed.

Smart Fix	X mm (SG 3041)	X mm (SG 3004)
SG 11200 / SG 11210	83	
SG 11201 / SG 11211	103	72
SG 11202 / SG 11212	123	92
SG 11203 / SG 11213	143	112
SG 11204 / SG 11214	173	142
SG 11205 / SG 11215	223	192
SG 11154	128-156	102-130
SG 11155	158-186	132-160
SG 11156	208-236	182-210

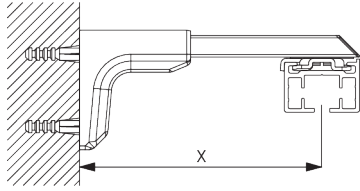

Universal Smart Fix SG 11154 - SG 11156 and clamp SG 3004:

Screw SG 11158 (M4x12) needed.

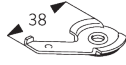

SG 3004
Clamp

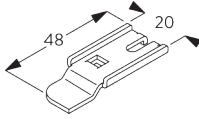

SG 3041
Bracket



SG 10074
Countersunk head screw
M4x8



SG 10407
Pan head screw M4x10



SG 10492
Pan head screw M4x8



SG 11158
Countersunk head screw
M4x12

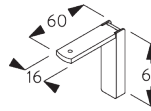

SG 11200
Smart Fix 60 mm

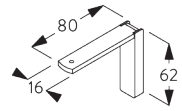

SG 11201
Smart Fix 80 mm

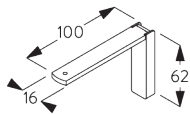

SG 11202
Smart Fix 100 mm

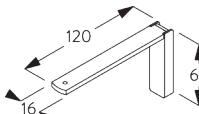

SG 11203
Smart Fix 120 mm

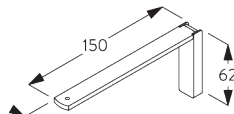

SG 11204
Smart Fix 150 mm

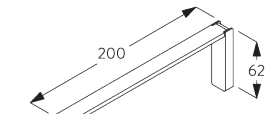

SG 11205
Smart Fix 200 mm

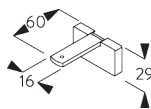

SG 11210
Square Smart Fix 60 mm

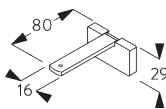

SG 11211
Square Smart Fix 80 mm

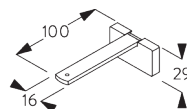

SG 11212
Square Smart Fix 100 mm

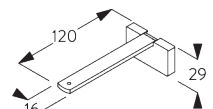

SG 11213
Square Smart Fix 120 mm

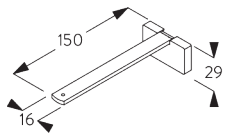

SG 11214
Square Smart Fix 150 mm

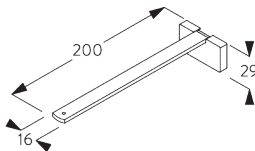

SG 11215
Square Smart Fix 200 mm

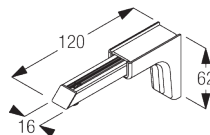

SG 11154
Universal Smart Fix 120 mm

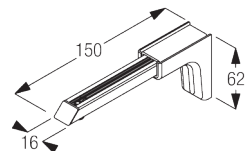

SG 11155
Universal Smart Fix 150 mm

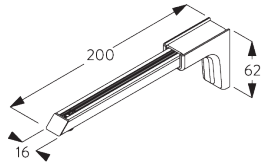

SG 11156
Universal Smart Fix 200 mm

D. RECESS FITTING

**Recess profile
 SG 10862**

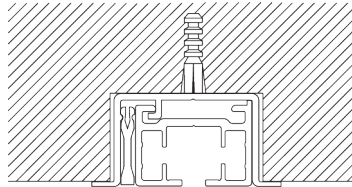

*One wedge SG 5118 per fixing point.
 For detailed recess fitting, visit the Silent Gliss website.*

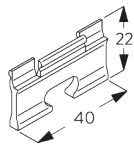

SG 5118
Wedge

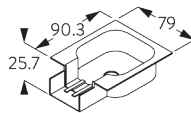

SG 10863
Recess mask

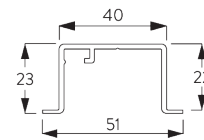

SG 10862
Recess profile

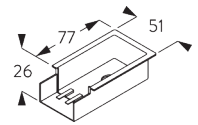

SG 10864
Recess mask

**Motor recessed in
 suspended ceiling**

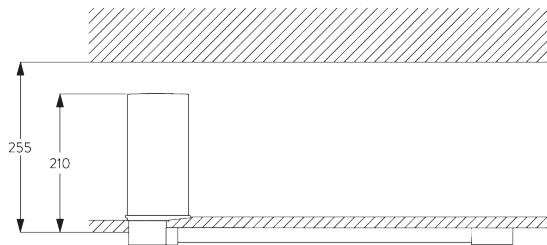

Profile mounted with clamp SG 3004.

*Access to the ceiling space is necessary for assembly /
 programming.*

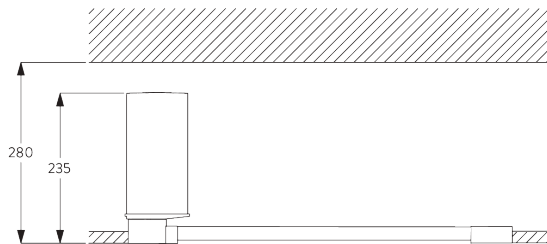

Profile SG 10862 recessed into ceiling.

*Access to the ceiling space is necessary for assembly /
 programming.*

SYSTEM OPTIONS

A. WAVE

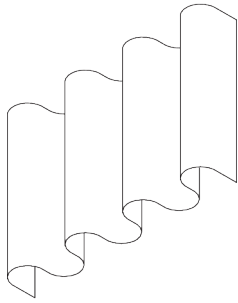

SG 6365



SG 10844

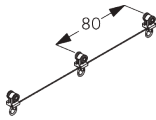

SG 10852



SG 10854



SG 10856



SG 10867



SG 10886



SG 10887

Standard components:

- SG 6365 Wave hanger
- SG 10844 Wave end stop
- SG 10852 Wave 2C roller cord, 80 mm
- SG 10854 Wave overlap arm support
- SG 10856 Wave end stop, belt return
- SG 10867 Panhead screw
- SG 10886 Wave extension
- SG 10887 Wave overlap arm set

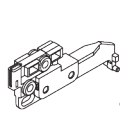

SG 10845

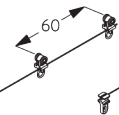

SG 10869

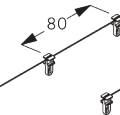

SG 10905

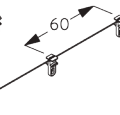

SG 10906

Optional components:

- SG 10845 Wave master carrier single stack 80 mm
- SG 10869 Wave 2C roller cord, 60 mm (no single stack)
- SG 10905 Wave glider cord, 80 mm
- SG 10906 Wave glider cord, 60 mm (no single stack)
- SG 10924 Wave glider support

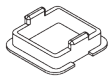

SG 10924



SG 3582

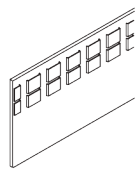

SG 6349

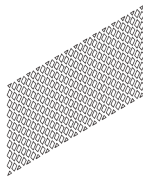

SG 6363

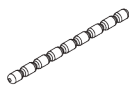

SG 10075



SG 10076

Curtain components:

- SG 3582 Hook
- SG 6349 Wave curtain tape
- SG 6363 Wave top hemming tape
- SG 10075 Lead weight 50 gr/m
- SG 10076 Fabric weight

Wave stack depth - 2C roller / glider cord (standard components)

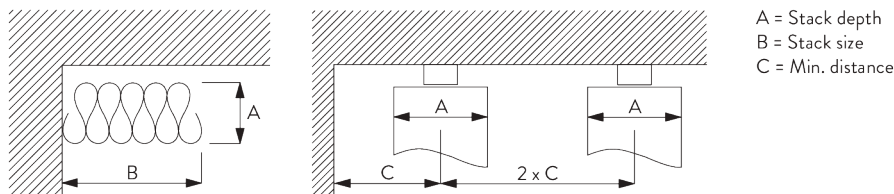

Roller / glider cord SG 10852 / 10905	Pockets between hooks	Approx. curtain fullness	Stack depth A	Stack size B*	Min distance C
80	6	~2.1	140	210 per metre of track	90
80	7	~2.3	160	210 per metre of track	100

Roller / glider cord SG 10869 / 10906	Pockets between hooks	Approx. curtain fullness	Stack depth A	Stack size B*	Min distance C
60	4	~2.1	100	260 per metre of track	70
60	5	~2.3	120	260 per metre of track	80

*Stack size B plus 190 mm for each curtain stack!

MOTOR & CONTROLS

A. MOTOR FEATURES

Motor	SG 9060
-------	---------

Motor Features

Soft start / stop	●
Touch & Go	●
Manual Override	●
Modular radio system (optional)	●
Electronic end-stop	●
Electronic revolution counter (unlimited revolution)	●
Two intermediate positions possible	●
Parallel wiring possible without additional relays	●
High-end DC motor with brushless technology	●
Permanent positioning sensor (even without power)	●
100 - 250 V AC and / or 24 V DC in one motor	●
Cable connectable with plug into motor	●
IP class	IP 40

Control Features

Mains power control	●
Dry contact control	●
Dry contact and / or SG Control L (with radio module)	●
Dry contact and / or SG Control R (with radio module)	●
SG Control L (with radio module)	●
SG Control R (with radio module)	●
Smart by Silent Gliss (with smart module)	●
Suitable for all common home automation systems (with suitable interface)	●

B. MOTOR SPECIFICATIONS

Motor	Motor dimensions	Voltage AC	Voltage DC	Current	Frequency	System speed / sec	Frequency receiver
SG 9060	L 206 x W 60 x D 96	100 - 250 V AC	24 V DC	1.3 - 0.5 A	50 - 60 Hz	21 cm / sec	n/a
SG 9060 w/ SG Control L	L 226 x W 60 x D 96	100 - 250 V AC	24 V DC	1.3 - 0.5 A	50 - 60 Hz	21 cm / sec	868/915 MHz
SG 9060 w/ SG Control R	L 226 x W 60 x D 96	100 - 250 V AC	24 V DC	1.3 - 0.5 A	50 - 60 Hz	21 cm / sec	433 MHz
SG 9060 w/ Smart by SG	L 226 x W 60 x D 96	100 - 250 V AC	24 V DC	1.3 - 0.5 A	50 - 60 Hz	21 cm / sec	Smart by SG

C. MOTOR DIMENSIONS / MODULES

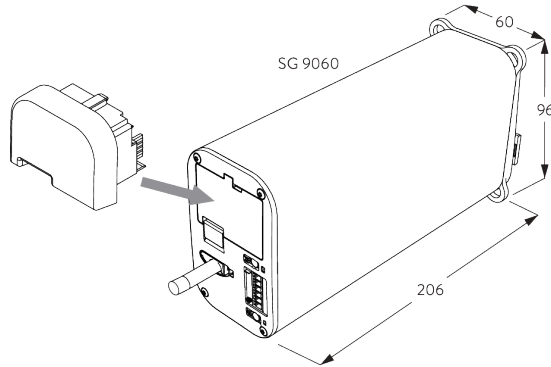

Motor SG 9060 can be equipped with following modules:

- SG 9063 Radio module SG Control L
- SG 11411 Radio module SG Control R
- SG 11270 Smart module

See catalogue "controls" for details.

D. OPERATING METHODS

See catalogue "controls" for details.

Wall switch



System can be operated by fixed wall switch.

SG Control L



Various radio hand-held and wall transmitters available.



Silent Gliss Move App.

SG Control R

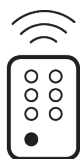

Various radio hand-held and wall transmitters available.

Smart by Silent Gliss



Open designed two-way communication system which allows to flawlessly integrate products with most major home control systems. Smart module SG 11270 required.

E. WIRING DIAGRAMS



Refer to Silent Gliss website.

GENERAL NOTES

Dimensions

- Measurements are in mm except where indicated.
- Max. kg relates to fabric incl. accessories.
- Stack size depends on curtain make-up and fabric thickness.
- Distance between gliders max. 80 mm / distance between rollers max. 100 mm.
- Recommended distance floor / fabric: 20 mm.
- In order to determine system height (B), the smallest room height must be taken into account.
- Full functionality may be affected if the curtain touches the profile.

Fitting

- Installation by qualified fitter only.
- Number of brackets and fitting positions / fixing points vary depending on fitting surface, system weight, fabric make-up, screw / fixing type and obstacles.
- Qualified fitter must use appropriate screws / fixings for each situation.
- Profile lip if applicable to be installed to room side.
- Electrical installations must be carried out according to Silent Gliss wiring diagrams and conform to local regulations.
- Check space for cables and plugs!

Child Safety

- All relevant Silent Gliss systems correspond to child safety EN 13120.
- All parties involved must comply with EN 13120.





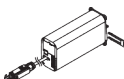
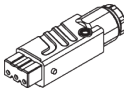
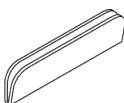
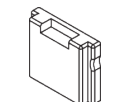
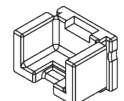
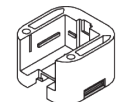
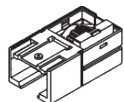
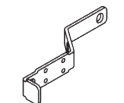
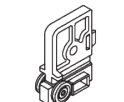
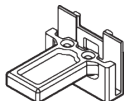
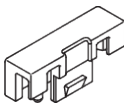
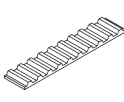
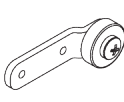

PARTS

A. STANDARD PARTS

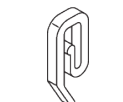
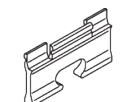
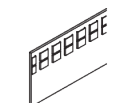
	SG 3004 Clamp
	SG 9060 Motor 100-250V AC & 24V DC
	SG 9917 Hirschmann portable socket-outlet STAK 3 N
	SG 10725 Programming distance holder
	SG 10815 Cover
	SG 10816 Cover
	SG 10817 Motor holder
	SG 10819 Belt return
	SG 10821 Overlap arm
	SG 10822 Master carrier
	SG 10823 Belt connector arm
	SG 10824 Belt connector pin
	SG 10825 Belt
	SG 10826 Overlap arm support

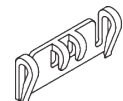
	SG 10836 Mask pair stack
	SG 10837 Pilot runner
	SG 10838 Pilot runner
	SG 10840 2C roller
	SG 10850 Profile
	SG 10923 Pan head screw Freedriv M4x12

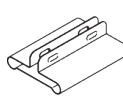
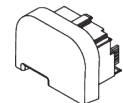
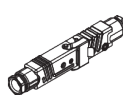
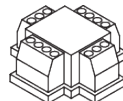
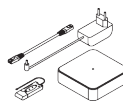
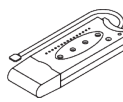
B. OPTIONAL PARTS

	SG 3041 Bracket
	SG 3582 Hook
	SG 5118 Wedge
	SG 6349 Wave curtain tape
	SG 6363 Wave top hemming tape
	SG 6365 Wave hanger
	SG 6794 Pan head screw 2.9x38 DIN 7981C
	SG 7002 Profile protector
	SG 9063 Radio module type L
	SG 9916 Hirschmann plug set
	SG 9959 Central control unit relay
	SG 9960 Move server set
	SG 9961 Move transmitter
	SG 10074 Countersunk head screw M4x8



SG 10075
Lead weight 50 g/m

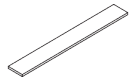

SG 10076
Fabric weight

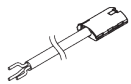

SG 10293
Cable 230V AC, 2/3/5/10 m



SG 10300
Radio hand held 1 channel



SG 10302
Radio hand held 5+1 channel



SG 10303
Radio hand held 10+2+1 channel

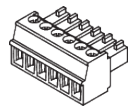

SG 10714
Plug 6-pin, MC 1.5/6-ST-3.81



SG 10804
Radio hand held 15+5+1 channel

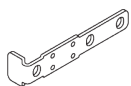

SG 10820
Overlap arm

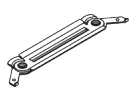

SG 10831
Connection bridge

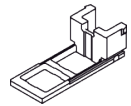

SG 10844
Wave end stop

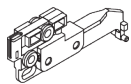

SG 10845
Wave master carrier

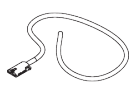

SG 10851
2 m cable UL certified incl. plug only for USA



SG 10852
Wave 2C roller cord 80 mm

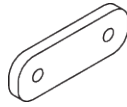

SG 10854
Wave overlap plate

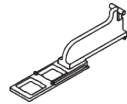

SG 10856
Wave extension

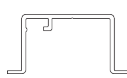

SG 10862
Recess profile

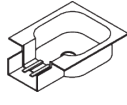

SG 10863
Recess mask

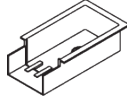

SG 10864
Recess mask

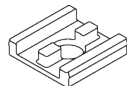

SG 10865
Support plate

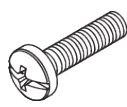

SG 10867
Pan head screw Freedriv M4x16



SG 10869
Wave 2C roller cord 60 mm

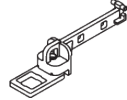

SG 10886
Wave extension

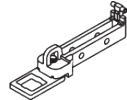

SG 10887
Wave extension

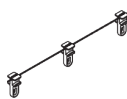

SG 10905
Wave glider cord 80 mm



SG 10906
Wave glider cord 60 mm

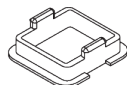

SG 10924
Wave glider support

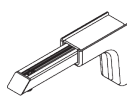

SG 11154
Universal Smart Fix 120 mm

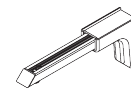

SG 11155
Universal Smart Fix 150 mm

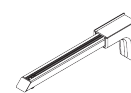

SG 11156
Universal Smart Fix 200 mm



SG 11158
Countersunk head screw M4x12

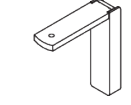

SG 11200
Smart Fix 60 mm

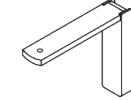

SG 11201
Smart Fix 80 mm

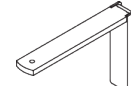

SG 11202
Smart Fix 100 mm

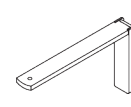

SG 11203
Smart Fix 120 mm

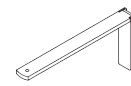

SG 11204
Smart Fix 150 mm



SG 11205
Smart Fix 200 mm

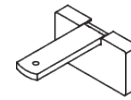

SG 11210
Square Smart Fix 60 mm

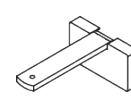

SG 11211
Square Smart Fix 80 mm

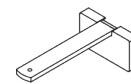

SG 11212
Square Smart Fix 100 mm

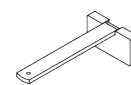

SG 11213
Square Smart Fix 120 mm

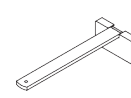

SG 11214
Square Smart Fix 150 mm

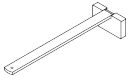
**SG 11215**

Square Smart Fix 200 mm

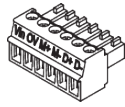
**SG 11325**

Smart plug 6-pin, MC 1.5/6 ST-3.81

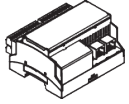
**SG 11260**

Smart controller gateway unit

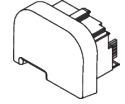
**SG 11411**

Radio module type R

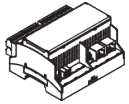
**SG 11261**

Smart controller gateway unit KNX

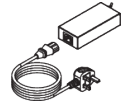
**SG 11412**

Power supply 24V / 4A lead including cable UK plug

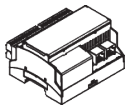
**SG 11262**

Smart controller expansion unit

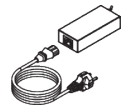
**SG 11414**

Power supply 24V / 4A including cable EU plug

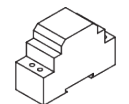
**SG 11263**

Power supply 24V DC, 2 Ampere DIN Rail

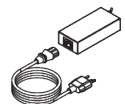
**SG 11415**

Power supply 24V / 4A including cable CH plug

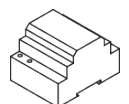
**SG 11264**

Power supply 24V DC, 3.8 Ampere DIN Rail

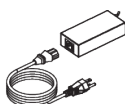
**SG 11416**

Power supply 24V / 4A including cable US plug

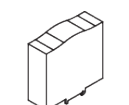
**SG 11265**

Power supply 24V DC, 5 Ampere DIN Rail

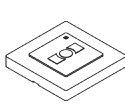
**SG 11480**

Radio wall transmitter 1 channel

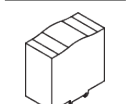
**SG 11266**

Power supply 24V DC, 10 Ampere DIN Rail

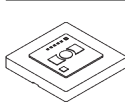
**SG 11490**

Radio wall transmitter 5+1 channel

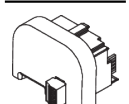
**SG 11270**

Smart module

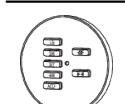
**SG 20336**

Hand held transmitter 8 channel

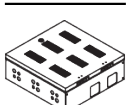
**SG 11281**

Cabinet for 8 systems

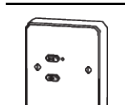
**SG 20913**

Wall switch single channel

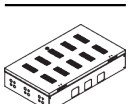
**SG 11282**

Cabinet for 24 systems

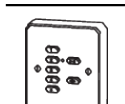
**SG 20914**

Wall switch 8 channel

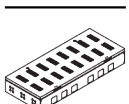
**SG 11283**

Cabinet for 56 systems

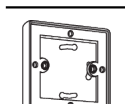
**SG 20917**

Pattress box

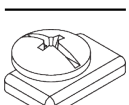
**SG 11295**

End stop

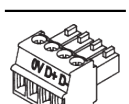
**SG 11318**

Plug 4-pin, MC 1.5/4-ST-3.5

