

# SG 1090

---

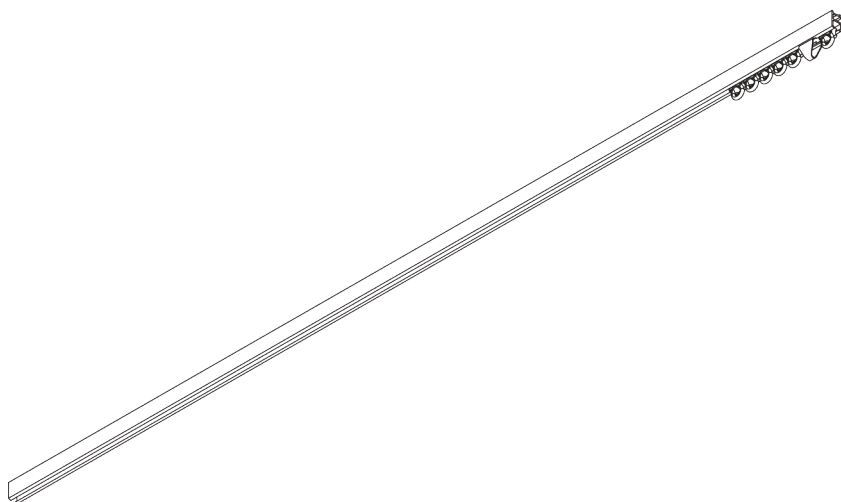

## PRODUCT INFORMATION

- **Operation:** hand
- **Range:** S
- **Fitting:** ceiling, wall
- **Colours:** white RAL 9016; special colours or anodised aluminum possible
- **Fabrics:** refer to Silent Gliss fabric collection

### **Features:**

- Bendable

# SYSTEM SPECIFICATIONS

## A. PROFILE

Profile and bending information

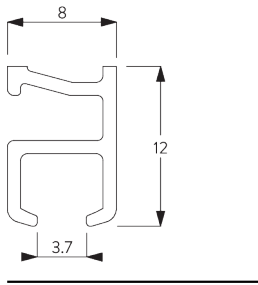

SG 1090p

Profile

Radius:  
✓ 6 cm, 10 cm

## B. HOW TO MEASURE

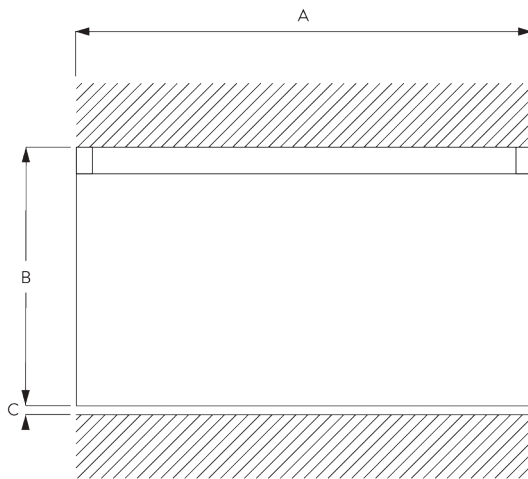

A: System width

B: System height

C: Distance between floor and fabric

## C. SPECIFICATION

### TEXT

**Silent Gliss SG 1090 Hand Operated Curtain Track System.** Comprises aluminium profile SG 1090 supplied made to measure in silver anodised or powder coated white, with gliders SG 3533 at 14/m and 2 end stops SG 3016 per length. Face fixed with nylon brackets SG 3175 / SG Smart Fix / top fixed with nylon bracket SG 3176 at max. 400 mm centres.

# FITTING

## A. FITTING INFORMATION

Fixing points

For detailed fitting information, visit the [Silent Gliss website](#).

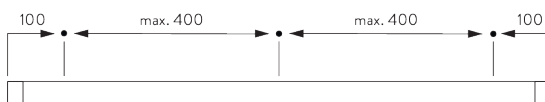

## B. CEILING FITTING

### Bracket SG 3176

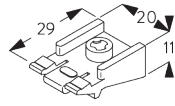
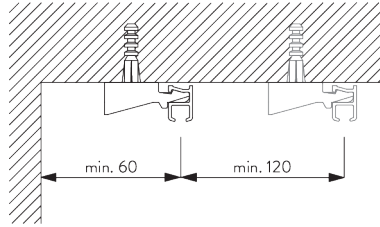

**SG 3176**  
Bracket

### Double ceiling bracket SG 3113 / SG 3115

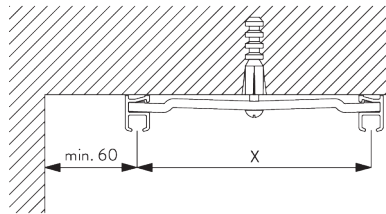

Bracket	X mm
SG 3113	57
SG 3115	80

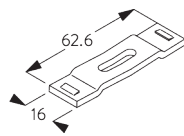

**SG 3113**  
Bracket

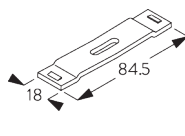

**SG 3115**  
Bracket

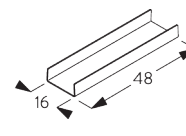

**SG 3255**  
Cover

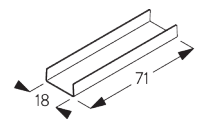

**SG 3256**  
Cover

## C. WALL FITTING

### Bracket SG 3175

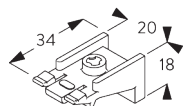
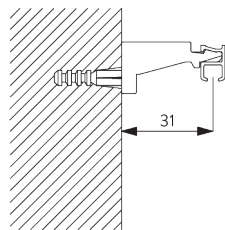

**SG 3175**  
Bracket

# Smart Fix

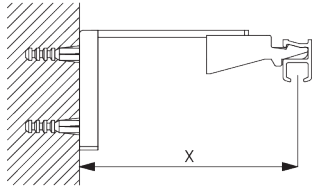

**Smart Fix SG 11200 - SG 11205 and bracket SG 3176:**  
Screw SG 10277 (M4x12) needed.

Smart Fix	X mm
SG 11200 / SG 11210	68
SG 11201 / SG 11211	88
SG 11202 / SG 11212	108
SG 11203 / SG 11213	128
SG 11204 / SG 11214	158
SG 11205 / SG 11215	208

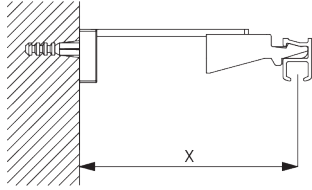

**Square Smart Fix SG 11210 - SG 11215 and bracket SG 3176:**  
Screw SG 10277 (M4x12) needed.

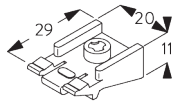

**SG 3176**  
Bracket



**SG 10277**  
Pan head screw M4x12

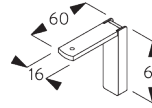

**SG 11200**  
Smart Fix 60 mm

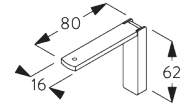

**SG 11201**  
Smart Fix 80 mm

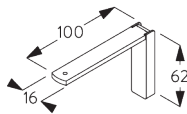

**SG 11202**  
Smart Fix 100 mm

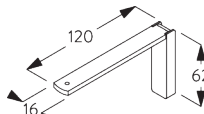

**SG 11203**  
Smart Fix 120 mm

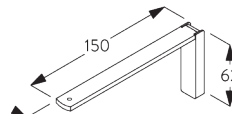

**SG 11204**  
Smart Fix 150 mm

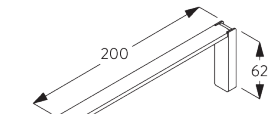

**SG 11205**  
Smart Fix 200 mm

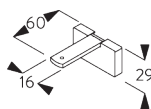

**SG 11210**  
Square Smart Fix 60 mm

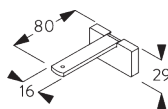

**SG 11211**  
Square Smart Fix 80 mm

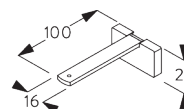

**SG 11212**  
Square Smart Fix 100 mm

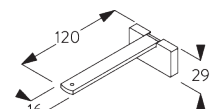

**SG 11213**  
Square Smart Fix 120 mm

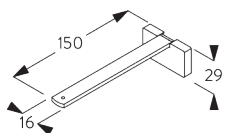

**SG 11214**  
Square Smart Fix 150 mm

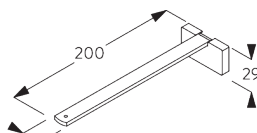

**SG 11215**  
Square Smart Fix 200 mm

# GENERAL NOTES

## **Dimensions**

- Measurements are in mm except where indicated.
- Max. kg relates to fabric incl. accessories.
- Stack size depends on curtain make-up and fabric thickness.
- Distance between gliders max. 80 mm / distance between rollers max. 100 mm.
- Recommended distance floor / fabric: 20 mm.
- In order to determine system height (B), the smallest room height must be taken into account.

## **Fitting**



- Installation by qualified fitter only.
- Number of brackets and fitting positions / fixing points vary depending on fitting surface, system weight, fabric make-up, screw / fixing type and obstacles.
- Qualified fitter must use appropriate screws / fixings for each situation.
- Profile lip if applicable to be installed to room side.

## **Child Safety**





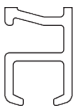
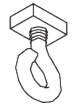
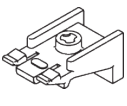







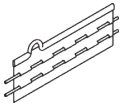
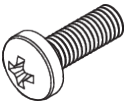
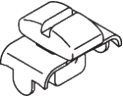
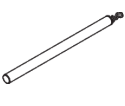
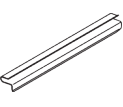

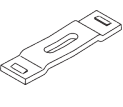
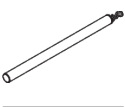

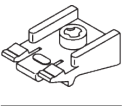
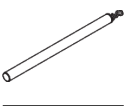
- All relevant Silent Gliss systems correspond to child safety EN 13120.
- All parties involved must comply with EN 13120.

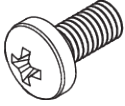
# PARTS

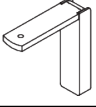
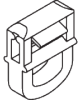
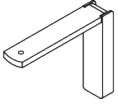
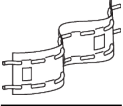
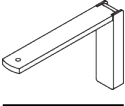
## A. STANDARD PARTS

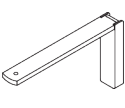
	<b>SG 1090p</b> Profile
	<b>SG 3016</b> End stop
	<b>SG 3175</b> Bracket
	<b>SG 3533</b> Glider

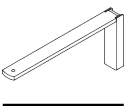
## B. OPTIONAL PARTS

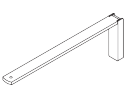
	<b>SG 3032</b> Spring stop		<b>SG 3599</b> Hook
	<b>SG 3068</b> Frizzing tape		<b>SG 10277</b> Pan head screw M4x12
	<b>SG 3071</b> End stop		<b>SG 10430</b> Draw rod 50 cm
	<b>SG 3096</b> Connection bridge		<b>SG 10431</b> Draw rod 75 cm
	<b>SG 3113</b> Bracket		<b>SG 10432</b> Draw rod 100 cm
	<b>SG 3151</b> Spacer		<b>SG 10433</b> Draw rod 125 cm
	<b>SG 3176</b> Bracket		<b>SG 10434</b> Draw rod 150 cm
	<b>SG 3511</b> Glider		<b>SG 10492</b> Pan head screw M4x8
	<b>SG 3534</b> Glider 3533 on strip		<b>SG 11200</b> Smart Fix 60 mm
	<b>SG 3548</b> Glider		<b>SG 11201</b> Smart Fix 80 mm
	<b>SG 3562</b> Heading tape		<b>SG 11202</b> Smart Fix 100 mm
	<b>SG 3570</b> Glider		<b>SG 11203</b> Smart Fix 120 mm
	<b>SG 3571</b> Hook		<b>SG 11204</b> Smart Fix 150 mm
	<b>SG 3582</b> Hook		<b>SG 11205</b> Smart Fix 200 mm

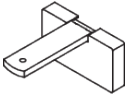

---

**SG 11210**  
*Square Smart Fix 60 mm*

---

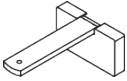

---

**SG 11211**  
*Square Smart Fix 80 mm*

---

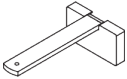

---

**SG 11212**  
*Square Smart Fix 100 mm*

---

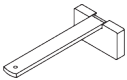

---

**SG 11213**  
*Square Smart Fix 120 mm*

---

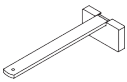

---

**SG 11214**  
*Square Smart Fix 150 mm*

---

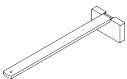

---

**SG 11215**  
*Square Smart Fix 200 mm*

---

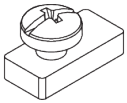

---

**SG 11335**  
*End stop*

---

