

SG 6380

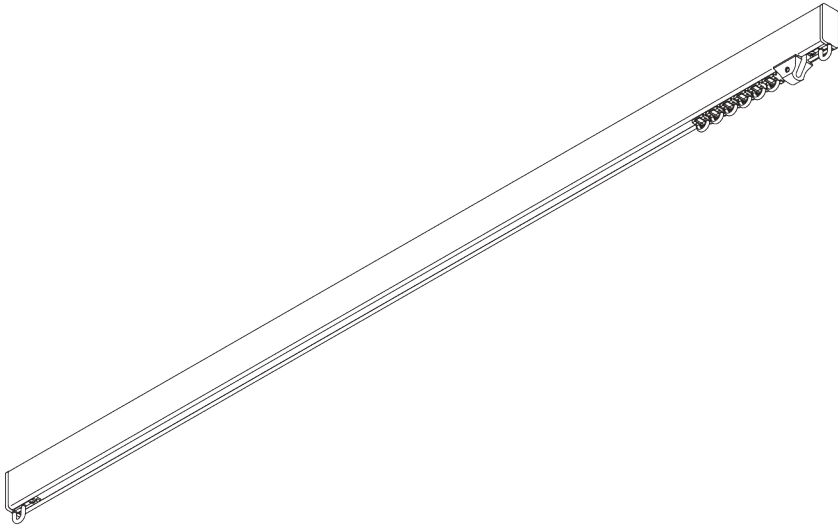
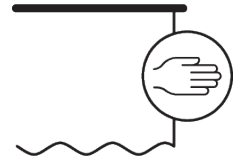

PRODUCT INFORMATION

- **Operation:** hand
- **Range:** M - L
- **Fitting:** ceiling, wall
- **Colours:** white RAL 9016; special colours or anodised aluminum possible
- **Fabrics:** refer to Silent Gliss fabric collection

Features:

- 2-component (2C) glider technology
- Wave (2C)
- Bendable

SYSTEM SPECIFICATIONS

A. PROFILE

Profile and bending information

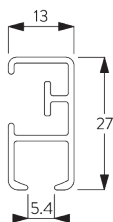

SG 6380p

Profile

Radius:
10 cm, >25 cm

B. HOW TO MEASURE

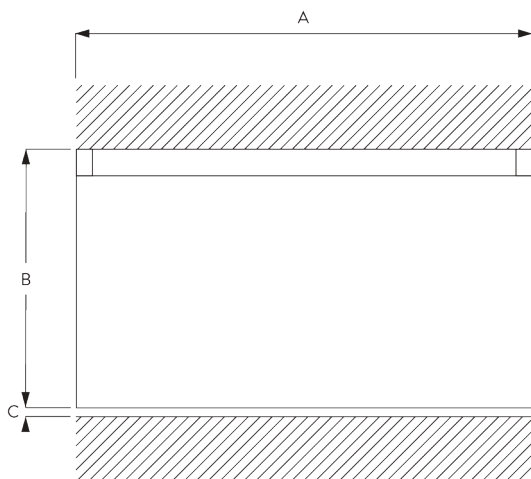

A: System width
B: System height
C: Distance between floor and fabric

C. SPECIFICATION TEXT

Silent Gliss SG 6380 Hand Operated Curtain Track System. Comprises aluminium profile SG 6380 supplied made to measure powder coated in white with 2C gliders SG 11300 at 14/m, 2 end covers SG 6381 and 2 end stops SG 6065 per length. Top fix with nylon bracket 3603. Wall fixed with brackets SG 3630 / SG 3655 / SG 3660 / SG Smart Fix brackets SG 11201-11205 / SG Square Smart Fix brackets SG 11210-11215 / SG Universal Smart Fix brackets SG 11154-11156. Silent Gliss Wave option is available using 60mm glider cord SG 11303 / 80mm glider cord SG 11302.

FITTING

A. FITTING INFORMATION

Fixing points

For detailed fitting information, visit the Silent Gliss website.

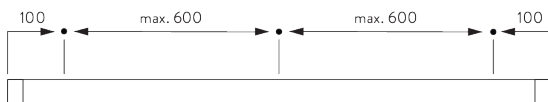

B. CEILING FITTING

Bracket SG 3603

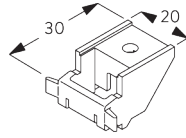
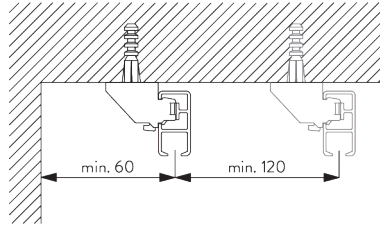

SG 3603
Bracket

C. WALL FITTING

Smart Fix

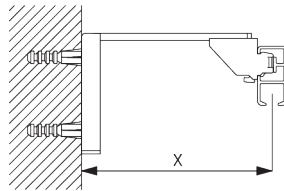

Smart Fix SG 11200 - SG 11205 and bracket SG 3603:
Screw SG 10492 (M4x8) needed.

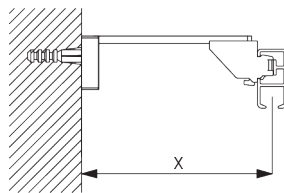

Square Smart Fix SG 11210 - SG 11215 and bracket SG 3603:
Screw SG 10492 (M4x8) needed.

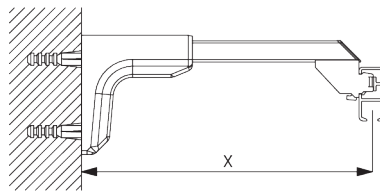

Universal Smart Fix SG 11154 - SG 11156 and bracket SG 3603:
Screw SG 10277 (M4x12) needed.

Smart Fix	X mm
SG 11200 / SG 11210	72
SG 11201 / SG 11211	92
SG 11202 / SG 11212	112
SG 11203 / SG 11213	132
SG 11204 / SG 11214	162
SG 11205 / SG 11215	212
SG 11154	122-150
SG 11155	152-180
SG 11156	202-230

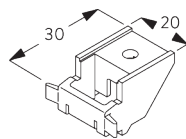

SG 3603
Bracket



SG 10277
Pan head screw M4x12



SG 10492
Pan head screw M4x8

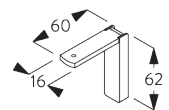

SG 11200
Smart Fix 60 mm

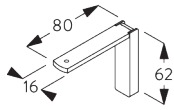

SG 11201
Smart Fix 80 mm

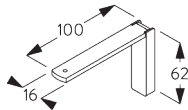

SG 11202
Smart Fix 100 mm

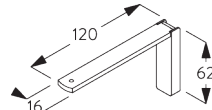

SG 11203
Smart Fix 120 mm

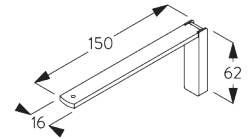

SG 11204
Smart Fix 150 mm

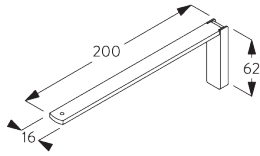

SG 11205
Smart Fix 200 mm

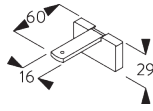

SG 11210
Square Smart Fix 60 mm

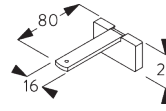

SG 11211
Square Smart Fix 80 mm

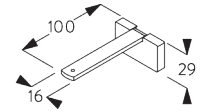

SG 11212
Square Smart Fix 100 mm

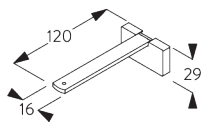

SG 11213
Square Smart Fix 120 mm

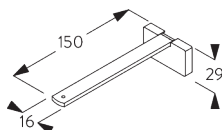

SG 11214
Square Smart Fix 150 mm

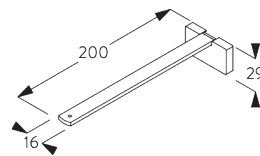

SG 11215
Square Smart Fix 200 mm

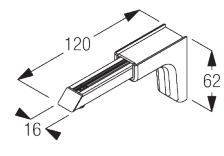

SG 11154
Universal Smart Fix 120 mm

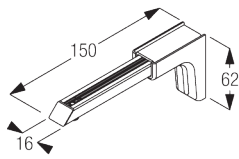

SG 11155
Universal Smart Fix 150 mm

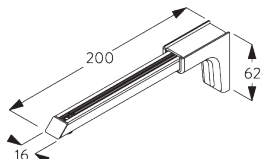

SG 11156
Universal Smart Fix 200 mm

**Universal Brackets
SG 3630, SG 3655,
SG 3660**

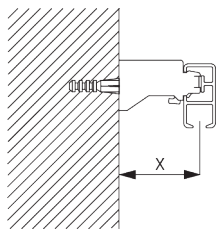

Bracket	X mm
SG 3630	35
SG 3655	50
SG 3660	65

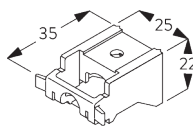

SG 3630
Bracket 35 mm

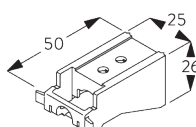

SG 3655
Bracket 50 mm

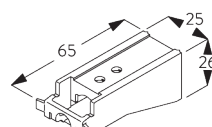

SG 3660
Bracket 65 mm

SYSTEM OPTIONS

A. WAVE

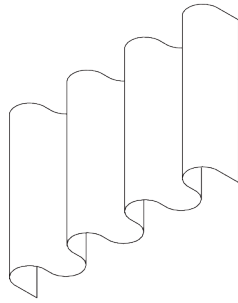

SG 11295

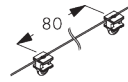

SG 11302



SG 2255

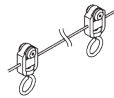

SG 6099

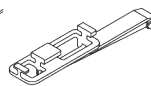

SG 6364



SG 6365

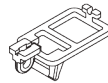

SG 6366

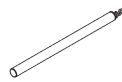

SG 10430-34

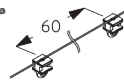

SG 11303

Standard components:

- SG 11295 End stop
- SG 11302 Wave 2C glider cord 80 mm

Optional components (min. radius >25 cm):

- SG 2255 Brake
- SG 6099 Wave roller cord 80 mm
- SG 6364 Wave extension
- SG 6365 Wave hanger
- SG 6366 Wave carrier for draw rod
- SG 10430-34 Draw rod
- SG 11303 Wave 2C glider cord 60 mm



SG 3582

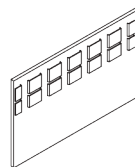

SG 6349

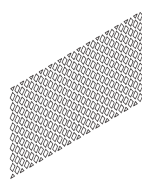

SG 6363

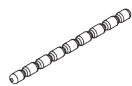

SG 10075



SG 10076

Curtain components:

- SG 3582 Hook
- SG 6349 Wave curtain tape
- SG 6363 Wave top hemming tape
- SG 10075 Lead weight 50 gr/m
- SG 10076 Fabric weight

Wave stack depth - 2C glider cord (standard components)

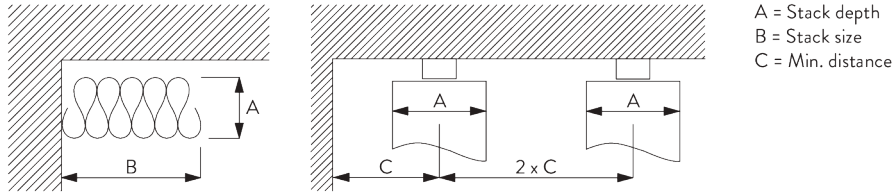

2C Glider cord SG 11302	Pockets between hooks	Approx. curtain fullness	Stack depth A	Stack size B*	Min distance C
80	6	~2.1	140	180 per metre of track	90
80	7	~2.3	160	180 per metre of track	100

2C Glider cord SG 11303	Pockets between hooks	Approx. curtain fullness	Stack depth A	Stack size B*	Min distance C
60	4	~2.1	100	230 per metre of track	70
60	5	~2.3	120	230 per metre of track	80

*Stack size B when using optional extension arm SG 6364 increases by 95 mm per curtain stack!

GENERAL NOTES

Dimensions

- Measurements are in mm except where indicated.
- Max. kg relates to fabric incl. accessories.
- Stack size depends on curtain make-up and fabric thickness.
- Distance between gliders max. 80 mm / distance between rollers max. 100 mm.
- Recommended distance floor / fabric: 20 mm.
- In order to determine system height (B), the smallest room height must be taken into account.

Fitting

- Installation by qualified fitter only.
- Number of brackets and fitting positions / fixing points vary depending on fitting surface, system weight, fabric make-up, screw / fixing type and obstacles.
- Qualified fitter must use appropriate screws / fixings for each situation.
- Profile lip if applicable to be installed to room side.

Child Safety

- All relevant Silent Gliss systems correspond to child safety EN 13120.
- All parties involved must comply with EN 13120.

PARTS

A. STANDARD PARTS

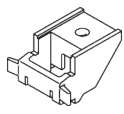

SG 3603

Bracket



SG 6065

End stop

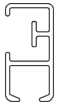

SG 6380p

Profile



SG 6381

End cover



SG 11300

2C glider

B. OPTIONAL PARTS

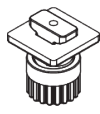

SG 2255

Brake



SG 3582

Hook



SG 3599

Hook

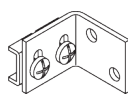

SG 3618

Wall bracket

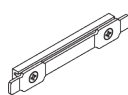

SG 3620

Connection bridge

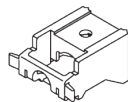

SG 3630

Bracket 35 mm

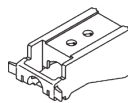

SG 3655

Bracket 50 mm

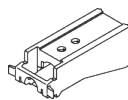

SG 3660

Bracket 65 mm



SG 6053

Spring stop

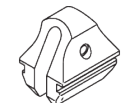

SG 6086

Spring stop



SG 6094

Roller



SG 6098

Roller

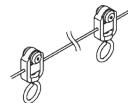

SG 6099

Wave roller cord 80 mm



SG 6283

Roller

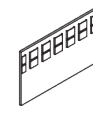

SG 6349

Wave curtain tape

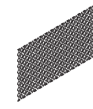

SG 6363

Wave top hemming tape

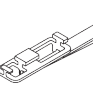

SG 6364

Wave extension

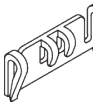

SG 6365

Wave hanger

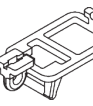

SG 6366

Wave carrier for draw rod



SG 10075

Lead weight 50 g/m

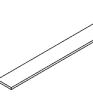

SG 10076

Fabric weight



SG 10277

Pan head screw M4x12

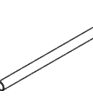

SG 10430

Draw rod 50 cm

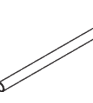

SG 10431

Draw rod 75 cm

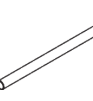

SG 10432

Draw rod 100 cm

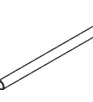

SG 10433

Draw rod 125 cm

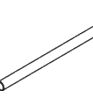

SG 10434

Draw rod 150 cm



SG 10492

Pan head screw M4x8

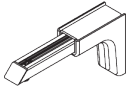

SG 11154
Universal Smart Fix 120 mm

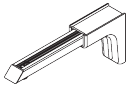

SG 11155
Universal Smart Fix 150 mm

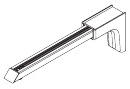

SG 11156
Universal Smart Fix 200 mm

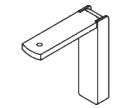

SG 11200
Smart Fix 60 mm

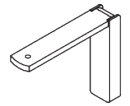

SG 11201
Smart Fix 80 mm

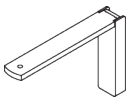

SG 11202
Smart Fix 100 mm

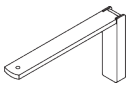

SG 11203
Smart Fix 120 mm

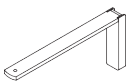

SG 11204
Smart Fix 150 mm



SG 11205
Smart Fix 200 mm

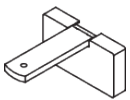

SG 11210
Square Smart Fix 60 mm

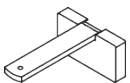

SG 11211
Square Smart Fix 80 mm

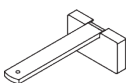

SG 11212
Square Smart Fix 100 mm

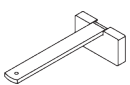

SG 11213
Square Smart Fix 120 mm

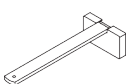

SG 11214
Square Smart Fix 150 mm

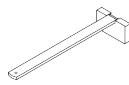

SG 11215
Square Smart Fix 200 mm

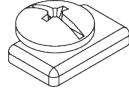

SG 11295
End stop



SG 11301
2C glider on strip

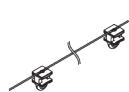

SG 11302
Wave 2C glider cord 80 mm

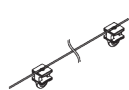

SG 11303
Wave 2C glider cord 60 mm