

SG 6465

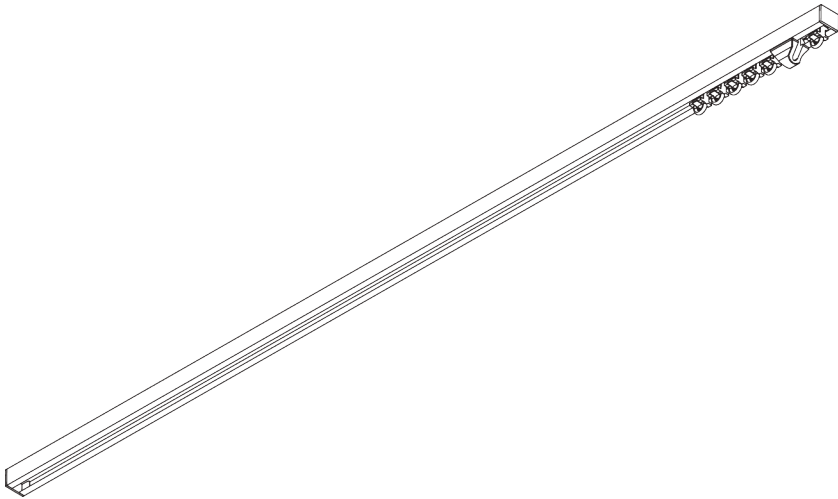

PRODUCT INFORMATION

- **Operation:** hand
- **Range:** S
- **Fitting:** ceiling, recess
- **Colours:** white RAL 9016; special colours or anodised aluminum possible (recess profile only in white RAL 9016 or special color)
- **Fabrics:** refer to Silent Gliss fabric collection

Features:

- 2-component (2C) glider technology
- Wave (2C)
- Bendable
- Bendable recess profile

SYSTEM SPECIFICATIONS

A. PROFILE

Profile and bending information

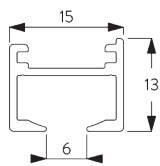

SG 6466

Profile

Radius:
✓ 8 cm, 12 cm, 16 cm,
>25 cm

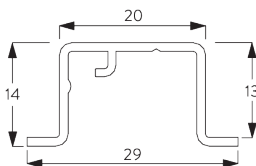

SG 11231

Recess profile

Radius:
✓ >27 cm

B. HOW TO MEASURE

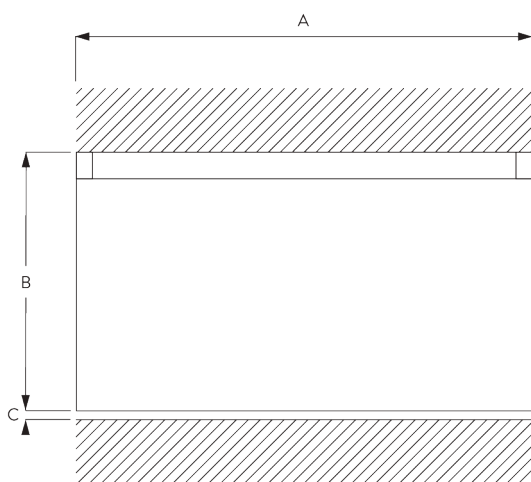

A: System width
B: System height
C: Distance between floor and fabric

C. SPECIFICATION TEXT

Silent Gliss SG 6465 Hand Operated Curtain Track System. Comprises aluminium profile SG 6466 supplied made to measure powder coated in white with 2C gliders SG 11300 at 14/m. Top fix with clamp SG 3060. Recess fix with optional recess profile SG 11231. Silent Gliss Wave option is available using 60mm glider cord SG 11303 / 80mm glider cord SG 11302.

FITTING

A. FITTING INFORMATION

Fixing points

For detailed fitting information, visit the [Silent Gliss website](#).

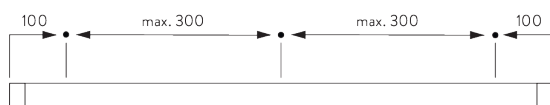

B. CEILING FITTING

Clamp SG 3060

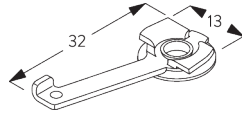
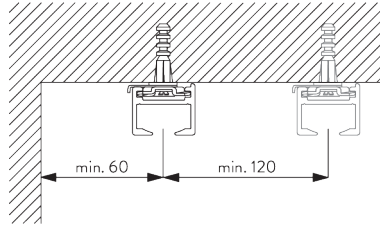

SG 3060

Clamp

C. RECESS FITTING

Recess profile SG 11231

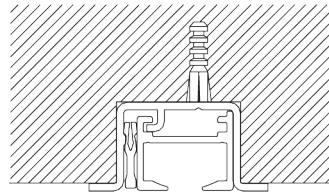

One wedge SG 11237 per fixing point.
For detailed recess fitting, visit the [Silent Gliss website](#).

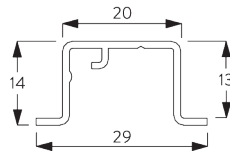

SG 11231

Recess profile

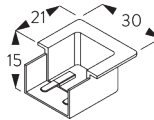

SG 11239

Recess Mask

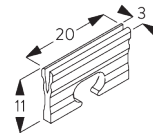

SG 11237

Wedge

SYSTEM OPTIONS

A. WAVE

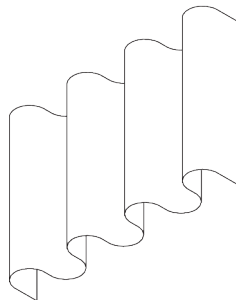

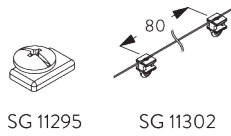

Standard components:

- SG 11295 End stop
- SG 11302 Wave 2C glider cord 80 mm

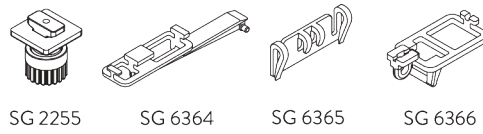

Optional components (min. radius >25 cm):

- SG 2255 Brake
- SG 6364 Wave extension
- SG 6365 Wave hanger
- SG 6366 Wave carrier for draw rod

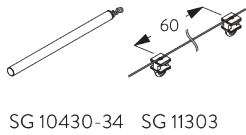

- SG 10430-34 Draw rod
- SG 11303 Wave 2C glider cord 60 mm

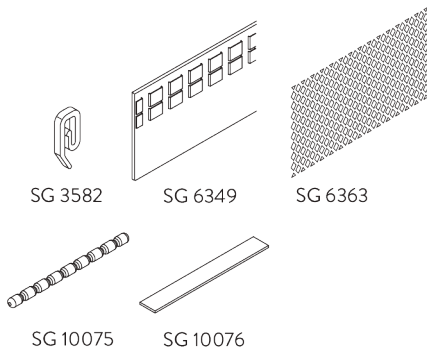

Curtain components:

- SG 3582 Hook
- SG 6349 Wave curtain tape
- SG 6363 Wave top hemming tape
- SG 10075 Lead weight 50 gr/m
- SG 10076 Fabric weight

Wave stack depth - 2C glider cord (standard components)

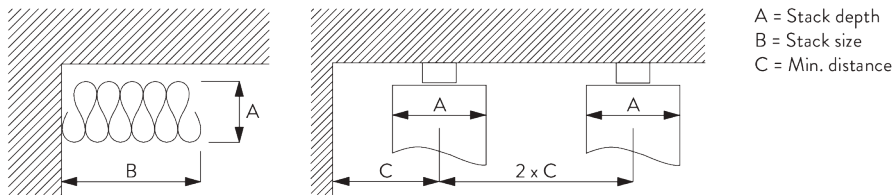

2C Glider cord SG 11302	Pockets between hooks	Approx. curtain fullness	Stack depth A	Stack size B*	Min distance C
80	6	~2.1	140	180 per metre of track	90
80	7	~2.3	160	180 per metre of track	100

2C Glider cord SG 11303	Pockets between hooks	Approx. curtain fullness	Stack depth A	Stack size B*	Min distance C
60	4	~2.1	100	230 per metre of track	70
60	5	~2.3	120	230 per metre of track	80

*Stack size B when using optional extension arm SG 6364 increases by 95 mm per curtain stack!

GENERAL NOTES

Dimensions

- Measurements are in mm except where indicated.
- Max. kg relates to fabric incl. accessories.
- Stack size depends on curtain make-up and fabric thickness.
- Distance between gliders max. 80 mm / distance between rollers max. 100 mm.
- Recommended distance floor / fabric: 20 mm.
- In order to determine system height (B), the smallest room height must be taken into account.

Fitting



- Installation by qualified fitter only.
- Number of brackets and fitting positions / fixing points vary depending on fitting surface, system weight, fabric make-up, screw / fixing type and obstacles.
- Qualified fitter must use appropriate screws / fixings for each situation.
- Profile lip if applicable to be installed to room side.

Child Safety





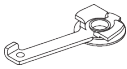

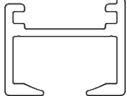
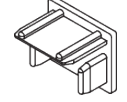
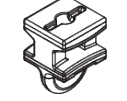



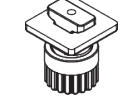
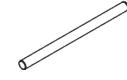

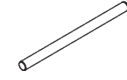
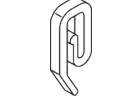

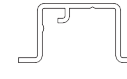

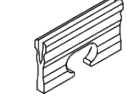
- All relevant Silent Gliss systems correspond to child safety EN 13120.
- All parties involved must comply with EN 13120.

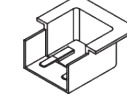
PARTS

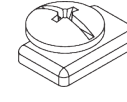
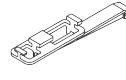
A. STANDARD PARTS

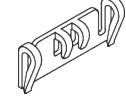
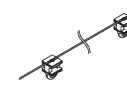
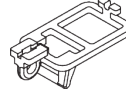
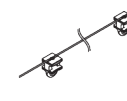
	SG 3060 Clamp
	SG 6065 End stop
	SG 6466 Profile
	SG 6471 End cover
	SG 11300 2C glider

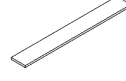
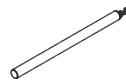
B. OPTIONAL PARTS

	SG 2255 Brake		SG 10432 Draw rod 100 cm
	SG 3062 Connection bridge		SG 10433 Draw rod 125 cm
	SG 3582 Hook		SG 10434 Draw rod 150 cm
	SG 3599 Hook		SG 11231 Recess profile
	SG 6064 End stop		SG 11237 Wedge
	SG 6349 Wave curtain tape		SG 11239 Recess Mask
	SG 6363 Wave top hemming tape		SG 11295 End stop
	SG 6364 Wave extension		SG 11301 2C glider on strip
	SG 6365 Wave hanger		SG 11302 Wave 2C glider cord 80 mm
	SG 6366 Wave carrier for draw rod		SG 11303 Wave 2C glider cord 60 mm
	SG 10075 Lead weight 50 g/m		
	SG 10076 Fabric weight		
	SG 10430 Draw rod 50 cm		
	SG 10431 Draw rod 75 cm		

