

# SG 6970

---

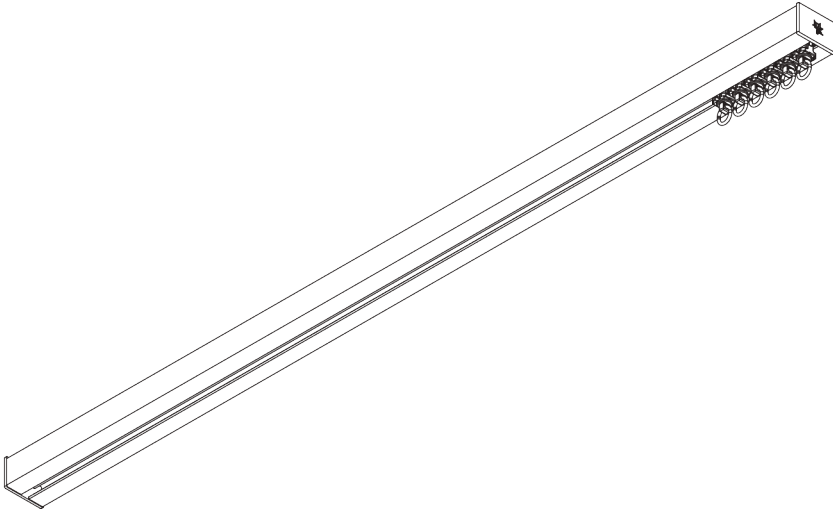

## PRODUCT INFORMATION

- **Operation:** hand
- **Range:** M - L
- **Fitting:** ceiling, wall, recess
- **Colours:** white RAL 9016; special colours or anodised aluminum possible (recess profile only in white RAL 9016 or special color)
- **Fabrics:** refer to Silent Gliss fabric collection

### **Features:**

- 2-component (2C) roller technology
- Wave (2C)
- Bendable
- Bendable recess profile

# SYSTEM SPECIFICATIONS

## A. PROFILE

Profile and bending information

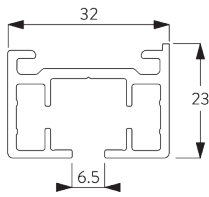

**SG 10850**

Profile

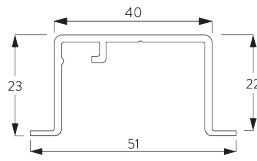

**SG 10862**

Recess profile

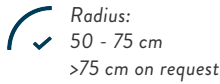

## B. HOW TO MEASURE

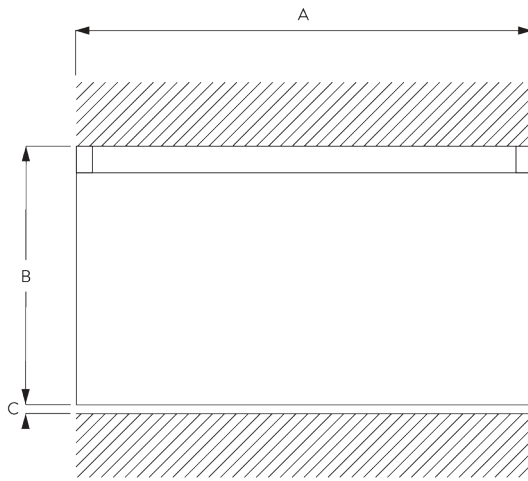

A: System width  
B: System height  
C: Distance between floor and fabric

## C. SPECIFICATION TEXT

**Silent Gliss SG 6970 Hand Operated Curtain Track System.** Comprises aluminium profile SG 10850 supplied made to measure available in silver anodised or powder coated in white. Supplied as standard with 2C roller gliders SG 10840 at 10/m, 2 end covers SG 11235 and 2 end stops SG 6007. Top fixed with fixing clamp SG 3004 at max. 500mm centres. Optional top fix with SG 3041 bracket or direct top fix with mounting plate SG 10865 and profile protector SG 7002. Wall fix with SG Smart Fix brackets SG 11201-11205 and SG 3041 or SG 3004 / SG Square Smart Fix brackets SG 11210-11215 and SG 3041 or SG 3004 / SG Universal Smart Fix brackets SG 11154-11156 and SG 3041 or SG 3004. Recess fix with recess profile SG 10862, recess masks SG 10864 and wedges SG 5118. Silent Gliss Wave option is available using 60mm glider cord 10869 / 80mm glider cord SG 10852.

# FITTING

## A. FITTING INFORMATION

Fixing points

For detailed fitting information, visit the Silent Gliss website.

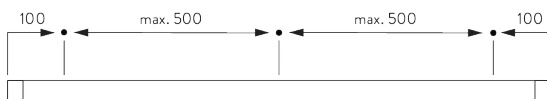

## B. CEILING FITTING

### Clamp SG 3004

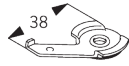
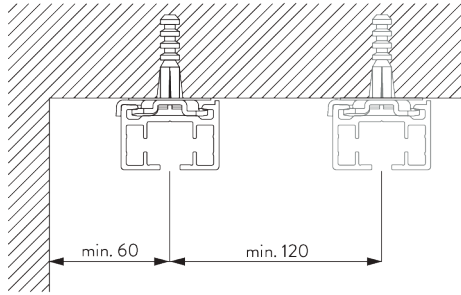

**SG 3004**

Clamp

### Direct fitting

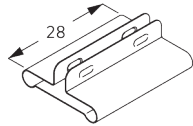
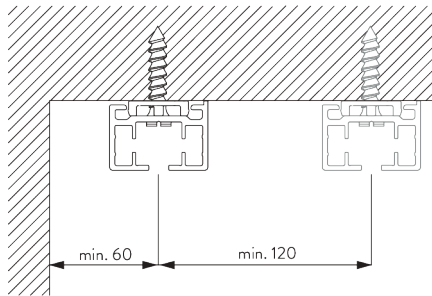

**SG 7002**

Profile protector

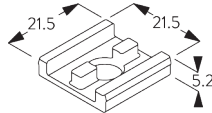

**SG 10865**

Support plate

### Bracket SG 3041

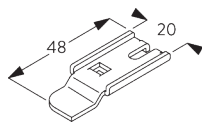
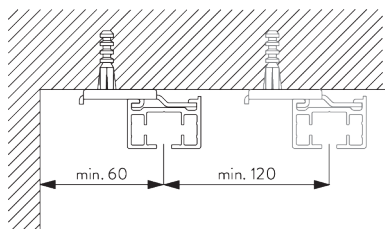

**SG 3041**

Bracket

## C. WALL FITTING

### Smart Fix

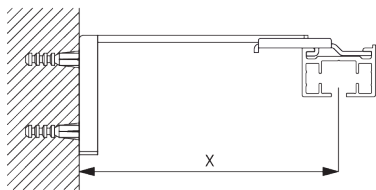

**Smart Fix SG 11200 - SG 11205 and bracket SG 3041:**  
Screw SG 10492 (M4x8) needed.

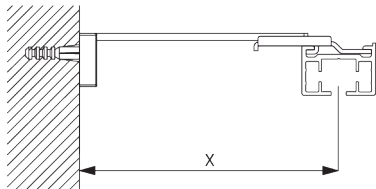

**Square Smart Fix SG 11210 - SG 11215 and bracket SG 3041:**  
Screw SG 10492 (M4x8) needed.

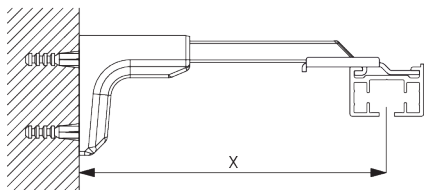

**Universal Smart Fix SG 11154 - SG 11156 and bracket SG 3041:**  
Screw SG 10407 (M4x10) needed.

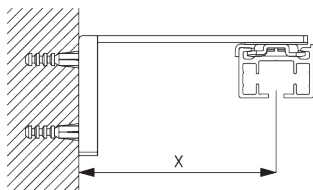

**Smart Fix SG 11201 - SG 11205 and clamp SG 3004:**  
Screw SG 10074 (M4x8) needed.

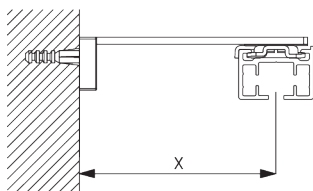

**Square Smart Fix SG 11211 - SG 11215 and clamp SG 3004:**  
Screw SG 10074 (M4x8) needed.

Smart Fix	X mm (SG 3041)	X mm (SG 3004)
SG 11200 / SG 11210	83	
SG 11201 / SG 11211	103	72
SG 11202 / SG 11212	123	92
SG 11203 / SG 11213	143	112
SG 11204 / SG 11214	173	142
SG 11205 / SG 11215	223	192
SG 11154	128-156	102-130
SG 11155	158-186	132-160
SG 11156	208-236	182-210

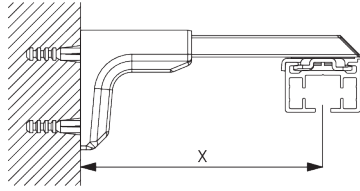

**Universal Smart Fix SG 11154 - SG 11156 and clamp  
SG 3004:**

Screw SG 11158 (M4x12) needed.

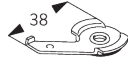

**SG 3004**

Clamp

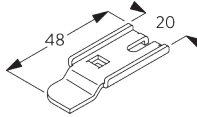

**SG 3041**

Bracket



**SG 10074**

Countersunk head screw  
M4x8



**SG 10407**

Pan head screw M4x10



**SG 10492**

Pan head screw M4x8



**SG 11158**

Countersunk head screw  
M4x12

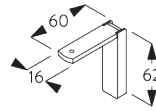

**SG 11200**

Smart Fix 60 mm

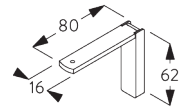

**SG 11201**

Smart Fix 80 mm

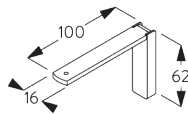

**SG 11202**

Smart Fix 100 mm

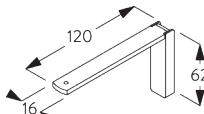

**SG 11203**

Smart Fix 120 mm

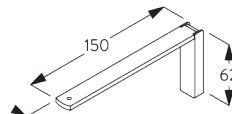

**SG 11204**

Smart Fix 150 mm

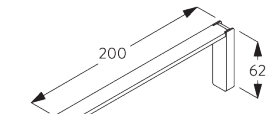

**SG 11205**

Smart Fix 200 mm

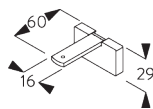

**SG 11210**

Square Smart Fix 60 mm

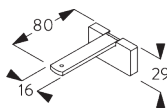

**SG 11211**

Square Smart Fix 80 mm

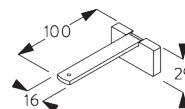

**SG 11212**

Square Smart Fix 100 mm

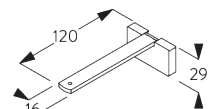

**SG 11213**

Square Smart Fix 120 mm

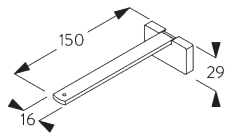

**SG 11214**

Square Smart Fix 150 mm

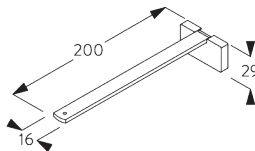

**SG 11215**

Square Smart Fix 200 mm

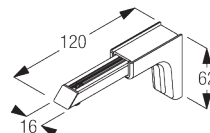

**SG 11154**

Universal Smart Fix 120 mm

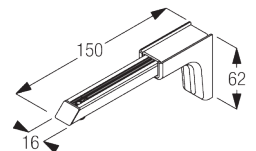

**SG 11155**

Universal Smart Fix 150 mm

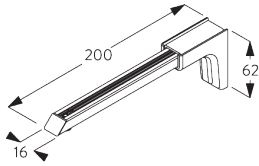

**SG 11156**

Universal Smart Fix 200 mm

## D. RECESS FITTING

Recess profile  
SG 10862

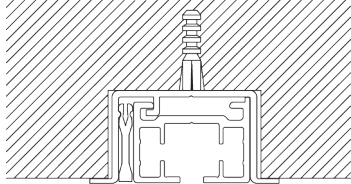

One wedge SG 5118 per fixing point.  
For detailed recess fitting, visit the Silent Gliss website.

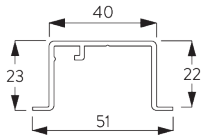

**SG 10862**

Recess profile

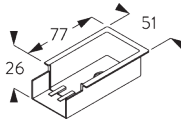

**SG 10864**

Recess mask

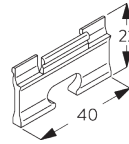

**SG 5118**

Wedge

# SYSTEM OPTIONS

## A. WAVE

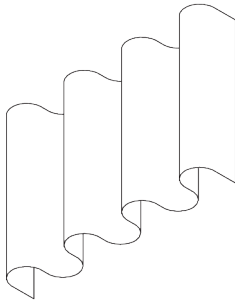

SG 11295

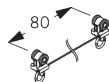

SG 10852

Standard components:

- SG 11295 End stop
- SG 10852 Wave 2C roller cord 80 mm

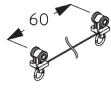

SG 10869

*Optional components:*

- SG 10869 Wave 2C roller cord 60 mm

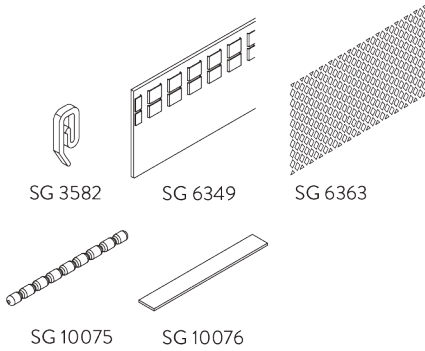

*Curtain components:*

- SG 3582 Hook
- SG 6349 Wave curtain tape
- SG 6363 Wave top hemming tape
- SG 10075 Lead weight 50 gr/m
- SG 10076 Fabric weight

Wave stack depth - 2C roller cord (standard components)

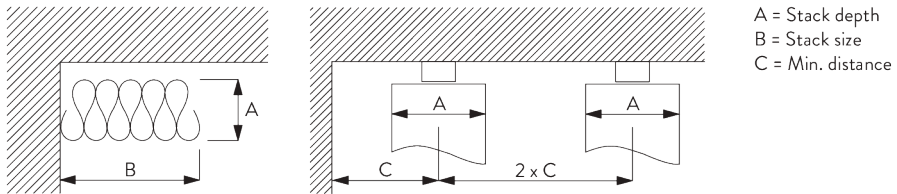

A = Stack depth  
B = Stack size  
C = Min. distance

2C Roller cord SG 10852	Pockets between hooks	Approx. curtain fullness	Stack depth A	Stack size B	Min distance C
80	6	~2.1	140	210 per metre of track	90
80	7	~2.3	160	210 per metre of track	100

2C Roller cord SG 10869	Pockets between hooks	Approx. curtain fullness	Stack depth A	Stack size B	Min distance C
60	4	~2.1	100	260 per metre of track	70
60	5	~2.3	120	260 per metre of track	80

# GENERAL NOTES

## **Dimensions**

- Measurements are in mm except where indicated.
- Max. kg relates to fabric incl. accessories.
- Stack size depends on curtain make-up and fabric thickness.
- Distance between gliders max. 80 mm / distance between rollers max. 100 mm.
- Recommended distance floor / fabric: 20 mm.
- In order to determine system height (B), the smallest room height must be taken into account.

## **Fitting**

- Installation by qualified fitter only.
- Number of brackets and fitting positions / fixing points vary depending on fitting surface, system weight, fabric make-up, screw / fixing type and obstacles.
- Qualified fitter must use appropriate screws / fixings for each situation.
- Profile lip if applicable to be installed to room side.





## **Child Safety**

- All relevant Silent Gliss systems correspond to child safety EN 13120.
- All parties involved must comply with EN 13120.





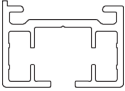
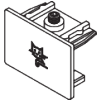



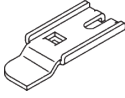
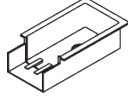

# PARTS

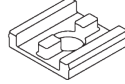
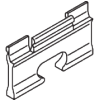
## A. STANDARD PARTS

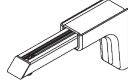
	<b>SG 3004</b> Clamp
	<b>SG 10840</b> 2C roller
	<b>SG 10850</b> Profile
	<b>SG 11235</b> End cover
	<b>SG 11465</b> Spring stop

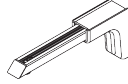
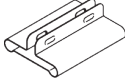
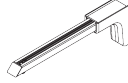
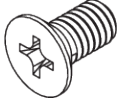
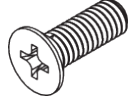
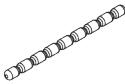
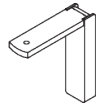
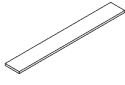
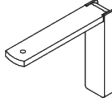
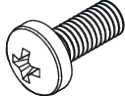
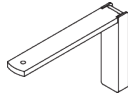
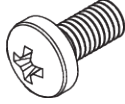
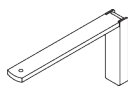
## B. OPTIONAL PARTS

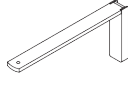
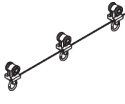
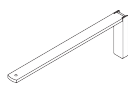
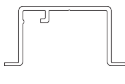
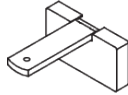
	<b>SG 3041</b> Bracket		<b>SG 10864</b> Recess mask
	<b>SG 3582</b> Hook		<b>SG 10865</b> Support plate
	<b>SG 5118</b> Wedge		<b>SG 10869</b> Wave 2C roller cord 60 mm
	<b>SG 6349</b> Wave curtain tape		<b>SG 11154</b> Universal Smart Fix 120 mm
	<b>SG 6363</b> Wave top hemming tape		<b>SG 11155</b> Universal Smart Fix 150 mm
	<b>SG 7002</b> Profile protector		<b>SG 11156</b> Universal Smart Fix 200 mm
	<b>SG 10074</b> Countersunk head screw M4x8		<b>SG 11158</b> Countersunk head screw M4x12
	<b>SG 10075</b> Lead weight 50 g/m		<b>SG 11200</b> Smart Fix 60 mm
	<b>SG 10076</b> Fabric weight		<b>SG 11201</b> Smart Fix 80 mm
	<b>SG 10407</b> Pan head screw M4x10		<b>SG 11202</b> Smart Fix 100 mm
	<b>SG 10492</b> Pan head screw M4x8		<b>SG 11203</b> Smart Fix 120 mm
	<b>SG 10831</b> Connection bridge		<b>SG 11204</b> Smart Fix 150 mm
	<b>SG 10852</b> Wave 2C roller cord 80 mm		<b>SG 11205</b> Smart Fix 200 mm
	<b>SG 10862</b> Recess profile		<b>SG 11210</b> Square Smart Fix 60 mm

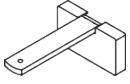

---

**SG 11211**  
*Square Smart Fix 80 mm*

---

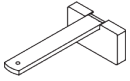

---

**SG 11212**  
*Square Smart Fix 100 mm*

---

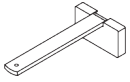

---

**SG 11213**  
*Square Smart Fix 120 mm*

---

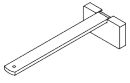

---

**SG 11214**  
*Square Smart Fix 150 mm*

---

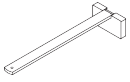

---

**SG 11215**  
*Square Smart Fix 200 mm*

---

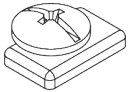

---

**SG 11295**  
*End stop*

---



