

# SG 2750

---

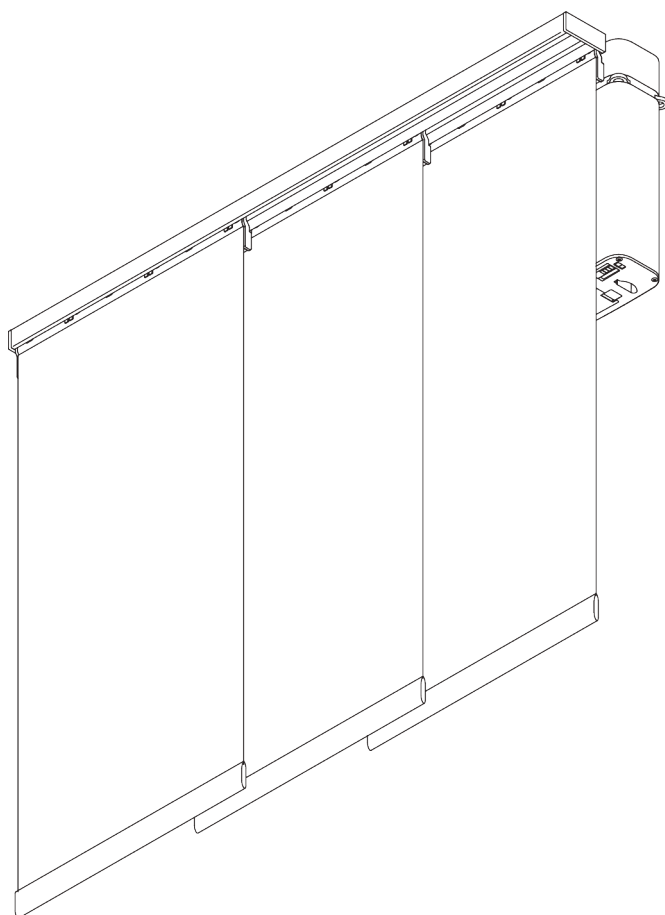

## PRODUCT INFORMATION

- **Operation:** motorised
- **Range:** S - L
- **Fitting:** ceiling
- **Colours:** white RAL 9016; special colours or anodised aluminum possible
- **Fabrics:** refer to Silent Gliss fabric collection

### **Features:**

- 2-component (2C) roller technology
- Silent and smooth running
- Aluminium carriers
- Applicable with electric curtain track system SG 5600

# SYSTEM SPECIFICATIONS

## A. SYSTEM DIMENSIONS



6 m

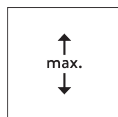

4 m



max. 2 kg per m

## B. PROFILE

### Profile information

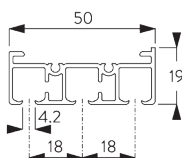

**SG 10123**

Profile 3-channel

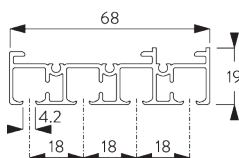

**SG 10124**

Profile 4-channel

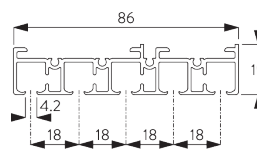

**SG 10125**

Profile 5-channel

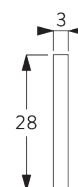

**SG 2006**

Bottom bar 28x3 mm

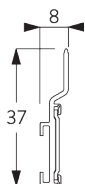

**SG 10230**

Carrier alu

## C. HOW TO MEASURE

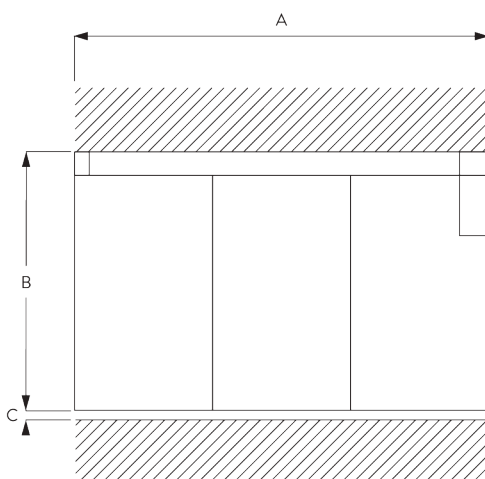

A: System width

B: System height

C: Distance between floor and fabric

## Dimensions of Panels

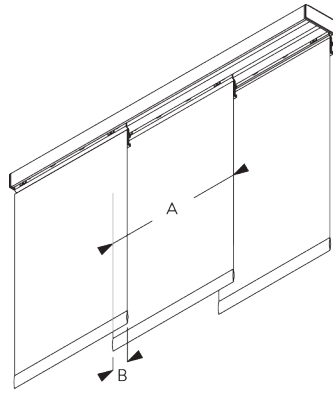

A: Recommended panel width: 500 - 1200

B: Overlap: min. 50

## D. SPECIFICATION

### TEXT

**Silent Gliss SG 2750 Electrically Operated Panel Glide System.** Supplied made to measure and complete comprising profiles SG 10123 / SG 10124 / SG 10125 as necessary with carriers SG 10230 with associated components and bottom weight SG 2006. Fabric panels stack right hand single / left hand single / pair / centre. Electrically operated (incorporating electric curtain track system SG 5600). Ceiling fixed using clamps SG 3003 / SG 3004. Fabric to be chosen from Silent Gliss fabric collection, Price Group 1 / 2 / 3 / 4.

# FITTING

## A. FITTING INFORMATION

For detailed fitting information, visit the [Silent Gliss website](#).

### Fixing points

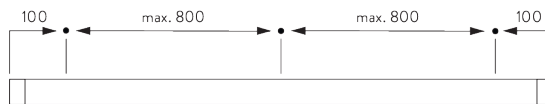

## B. CEILING FITTING

### With SG 5600

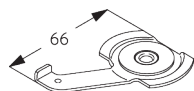
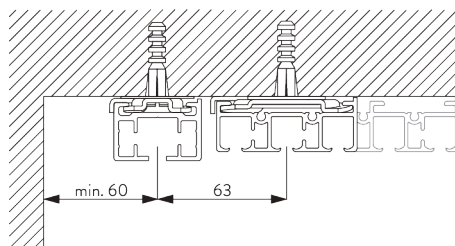

**SG 3003**  
Clamp

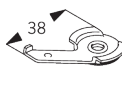

**SG 3004**  
Clamp

# SYSTEM OPTIONS

## A. MOTORISATION

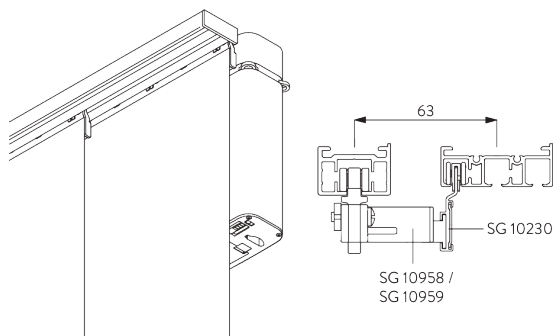

### Motorised with SG 5600

- Single stack systems: carrier SG 10958
- Pair stack systems: carriers SG 10958 / SG 10959

For further details refer to the electric curtain track catalogue.

## B. PANEL STACKING



Single stack

Note: dot = fixed panel



Pair stack

Note: dot = fixed panel

Other variations are possible.

# GENERAL NOTES

## **Dimensions**

- Measurements are in mm except where indicated.
- Max. kg relates to fabric incl. accessories.
- Stack size depends on panel width.
- Recommended distance floor / fabric: 20 mm.
- In order to determine system height (B), the smallest room height must be taken into account.

## **Fitting**

- Installation by qualified fitter only.
- Number of brackets and fitting positions / fixing points vary depending on fitting surface, system weight, fabric make-up, screw / fixing type and obstacles.
- Qualified fitter must use appropriate screws / fixings for each situation.
- Profile lip if applicable to be installed to room side.
- Electrical installations must be carried out according to Silent Gliss wiring diagrams and conform to local regulations.
- Check space for cables and plugs!

## **Child Safety**

- All relevant Silent Gliss systems correspond to child safety EN 13120.
- All parties involved must comply with EN 13120.

# PARTS

## A. STANDARD PARTS

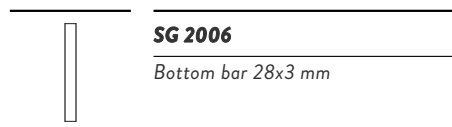

**SG 2006**

Bottom bar 28x3 mm



**SG 2539**

Tape

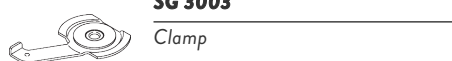

**SG 3003**

Clamp

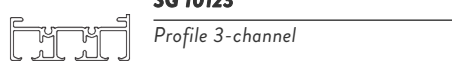

**SG 10123**

Profile 3-channel

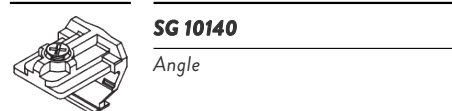

**SG 10140**

Angle



**SG 10143**

Cover

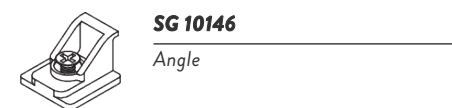

**SG 10146**

Angle



**SG 10156**

End stop

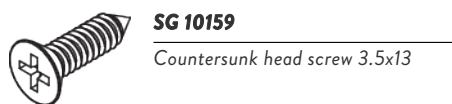

**SG 10159**

Countersunk head screw 3.5x13

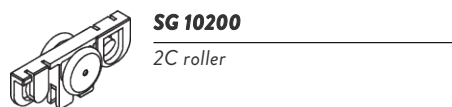

**SG 10200**

2C roller



**SG 10230**

Carrier alu

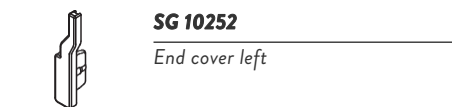

**SG 10252**

End cover left



**SG 10253**

End cover right



**SG 10958**

Panel carrier for electric track

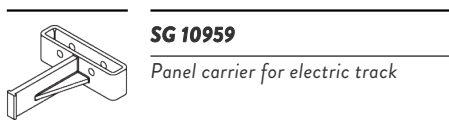

**SG 10959**

Panel carrier for electric track

## B. OPTIONAL PARTS

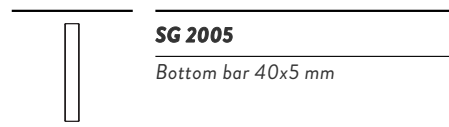

**SG 2005**

Bottom bar 40x5 mm

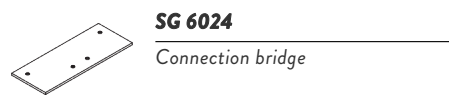

**SG 6024**

Connection bridge

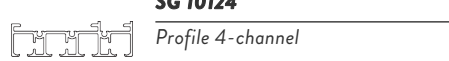

**SG 10124**

Profile 4-channel

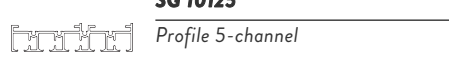

**SG 10125**

Profile 5-channel

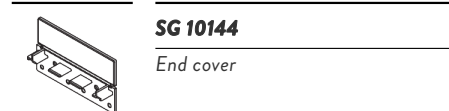

**SG 10144**

End cover

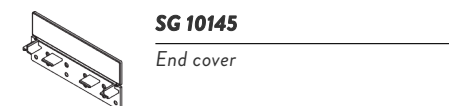

**SG 10145**

End cover



