

# SG 4910

---

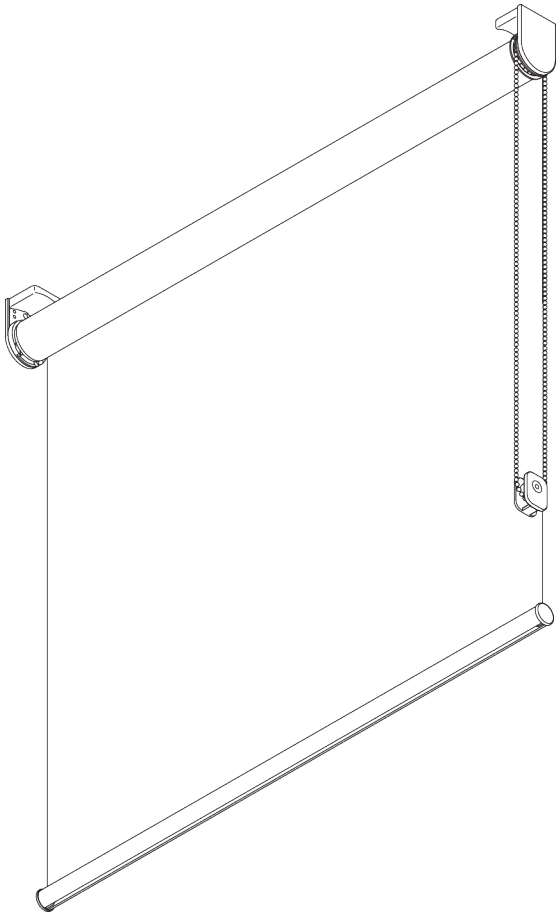

## PRODUCT INFORMATION

- **Operation:** chain
- **Range:** S - M
- **Fitting:** ceiling, wall, recess
- **Colours:** white RAL 9016; special colours or anodised aluminum possible
- **Fabrics:** refer to Silent Gliss fabric collection

### **Features:**

- Spring assisted, effortless operation
- 1-to-1 gear drive
- Stainless steel bead chain
- Click-in brackets
- Fascia, box, installation profile
- End stop controller

09/2021/V1

# SYSTEM SPECIFICATIONS

## A. SYSTEM DIMENSIONS

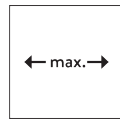

2.4 m

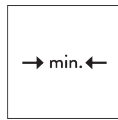

25 cm\*,  
Fascia / Box: 60 cm  
\*25 - 60 cm only with  
installation profile  
SG 10534

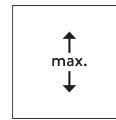

3 m



7.2 m<sup>2</sup>



3 kg

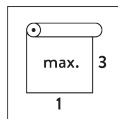

Recommended width /  
height ratio  
max. 1:3

## Maximum system drop

Wall fitting (system drop on window side):

Fabric thickness	mm	0.15	0.20	0.25	0.30	0.35	0.40	0.45	0.50	0.55	0.60	0.65	0.70	0.75	0.80
Max. system drop	cm	300	300	300	300	300	300	300	300	300	290	270	250	230	220

Ceiling fitting / wall fitting (system drop on room side):

Fabric thickness	mm	0.15	0.20	0.25	0.30	0.35	0.40	0.45	0.50	0.55	0.60	0.65	0.70	0.75	0.80
Max. system drop	cm	300	300	300	300	300	300	300	300	300	300	300	300	300	280

## B. PROFILE

### Profile information

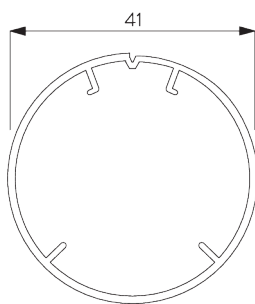

**SG 10531**  
Tube ø 41 mm

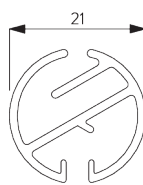

**SG 4221**  
Bottom bar

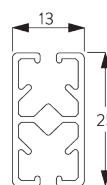

**SG 10633**  
Bottom bar

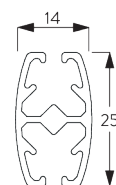

**SG 10634**  
Bottom bar

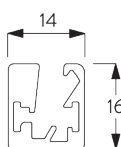

**SG 11442**  
Bottom bar

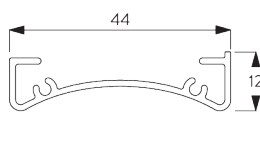

**SG 10534**  
Installation profile

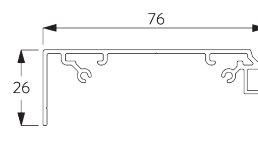

**SG 11430**  
Installation profile fascia 73 mm

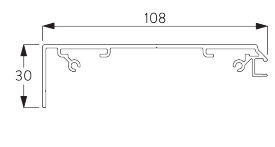

**SG 11530**  
Installation profile fascia 110 mm

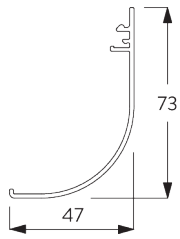

**SG 11431**  
Fascia round 73 mm

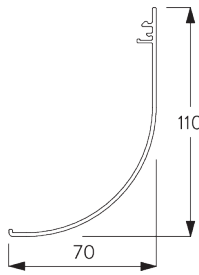

**SG 11531**  
Fascia round 110 mm

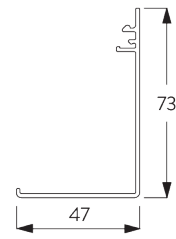

**SG 11432**  
Fascia square 73 mm

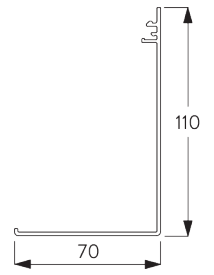

**SG 11532**  
Fascia square 110 mm

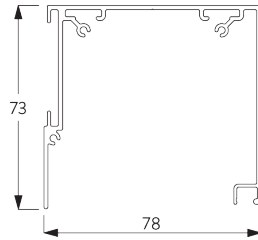

**SG 11433**  
Box case 73 mm

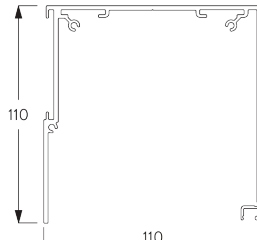

**SG 11533**  
Box case 110 mm

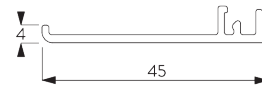

**SG 11434**  
Box cover 73 mm

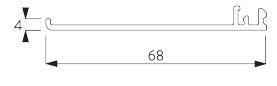

**SG 11534**  
Box cover 110 mm

### C. HOW TO MEASURE

*incl. bracket covers*

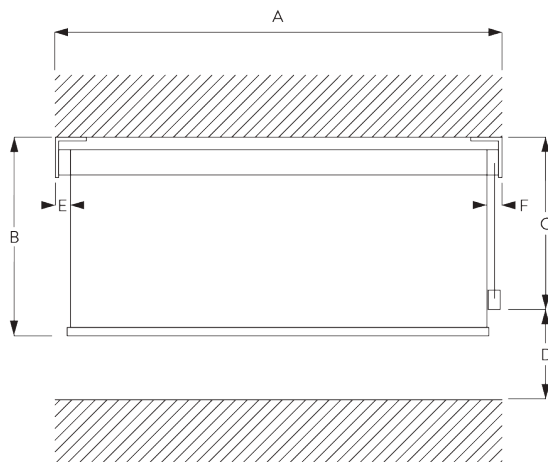

- A: System width
- B: System height
- C: Chain height
- D: Safety Retainer SG 10731 min. 150 cm above floor
- E: Light gap: 13 mm
- F: Light gap operation side: 18 mm

**Note:**  
All measurements include 2 mm for bracket cover per side!  
These can be omitted to reduce side light gaps.

## Fascia / Box

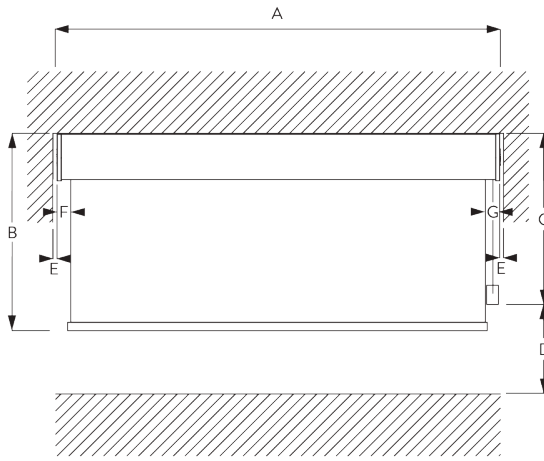

- A: System width
- B: System height
- C: Chain height
- D: Safety Retainer SG 10731 min. 150 cm above floor
- E: Gap: min. 10 mm (when cover is used)
- F: Light gap: 15 mm
- G: Light gap operation side: 21 mm

## D. SPECIFICATION TEXT

**Silent Gliss SG 4910 Chain Operated Roller Blind System.** Roller blind system for medium to large size blind applications up to 2.4m wide. Supplied made to measure and complete comprising anodised aluminium barrel SG 10531 with counterbalancing spring and planetary gear set ensuring light, precise movement. Fixed to wall / ceiling/inside recess with brackets SG 10542 / SG 10543 and bracket covers SG 10574 / SG 10575. Optional installation profile SG 10534. Assembled with powder coated white finish aluminium bottom weight bar SG 4221 as standard (other shape options available). Optional adjustable end stop SG 10559 / SG 10560 allows upper or lower stop limit setting. Compliant to Child Safety legislation EN 13120. Fabric to be chosen from the Silent Gliss fabric range, Price Group 1R / 2R / 3R.

# FITTING

## A. FITTING INFORMATION

For detailed fitting information, visit the Silent Gliss website.

### Fixing points



Brackets (wall / ceiling)

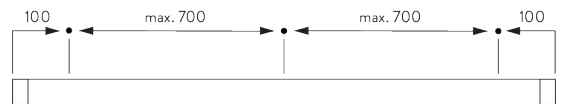

Fascia / box & installation profile SG 10534 (wall / ceiling)

## B. CEILING FITTING

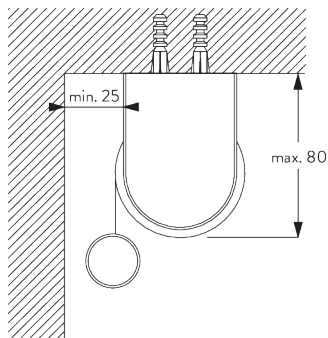

Brackets

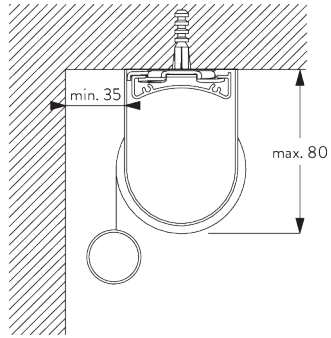

*Installation profile SG 10534 and clamp SG 3044*

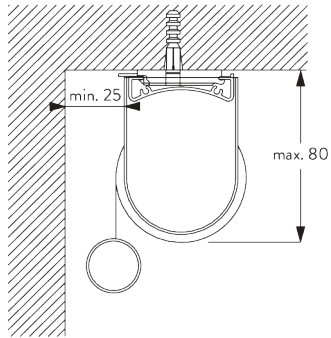

*Installation profile SG 10534 and click bracket SG 10539*

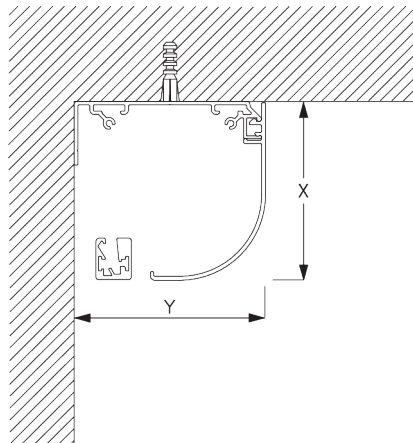

**Fascia round**

*X = Fascia S 73 mm / Fascia L 110 mm*

*Y = Fascia S 78 mm / Fascia L 110 mm*

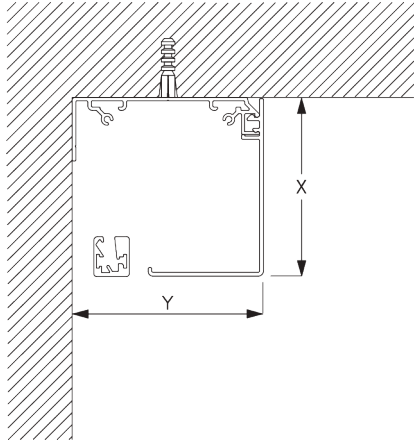

**Fascia square**

X = Fascia S 73 mm / Fascia L 110 mm

Y = Fascia S 78 mm / Fascia L 110 mm

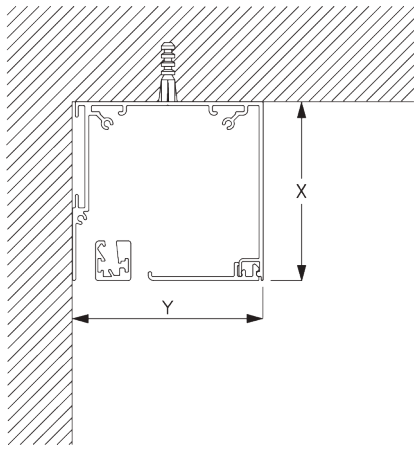

**Box**

X = Box S 73 mm / Box L 110 mm

Y = Box S 78 mm / Box L 110 mm

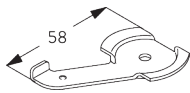

**SG 3044**

Clamp

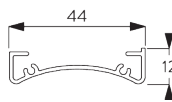

**SG 10534**

Installation profile

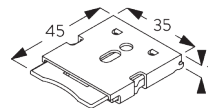

**SG 10539**

Bracket

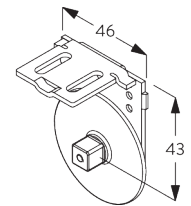

**SG 10542**

Bracket

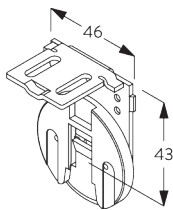

**SG 10543**

Bracket

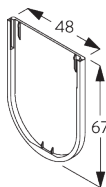

**SG 10574**

Bracket cover

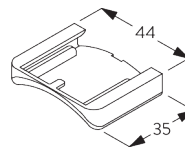

**SG 10575**

Bracket cover

## C. WALL FITTING

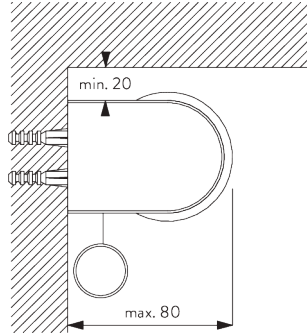

**Brackets**

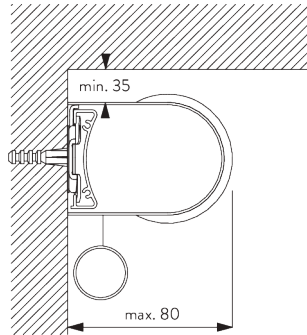

**Installation profile SG 10534 and clamp SG 3044**

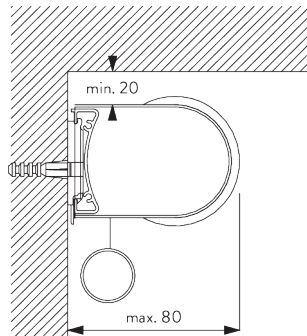

**Installation profile SG 10534 and click bracket SG 10539**

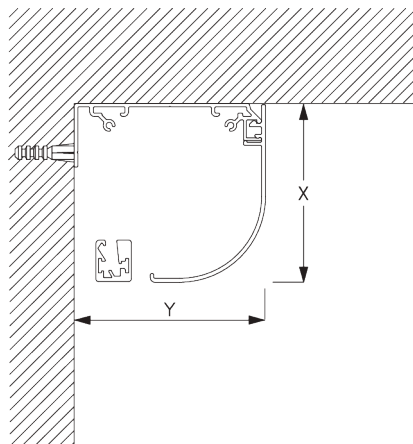

**Fascia round**

X = Fascia S 73 mm / Fascia L 110 mm

Y = Fascia S 78 mm / Fascia L 110 mm

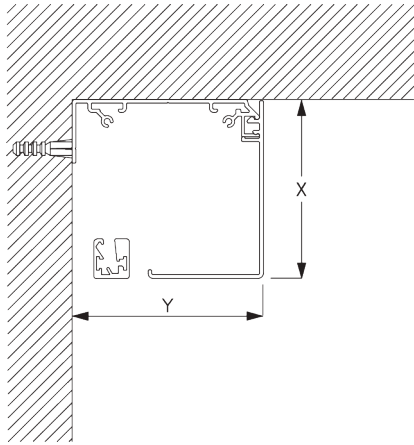

**Fascia square**

X = Fascia S 73 mm / Fascia L 110 mm

Y = Fascia S 78 mm / Fascia L 110 mm

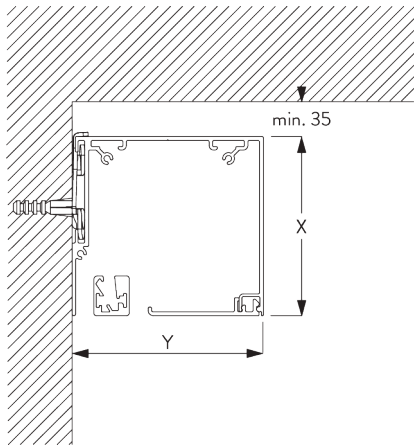

**Box S and clamp SG 3044 / Box L and clamp SG 11180**

X = Box S 73 mm / Box L 110 mm

Y = Box S 78 mm / Box L 110 mm

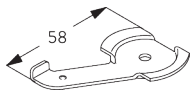

**SG 3044**

Clamp

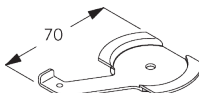

**SG 11180**

Clamp

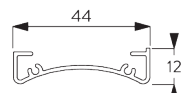

**SG 10534**

Installation profile

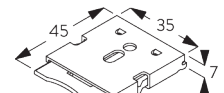

**SG 10539**

Bracket

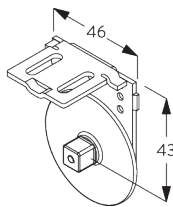

**SG 10542**

Bracket

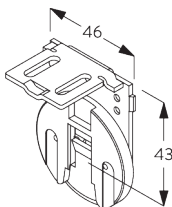

**SG 10543**

Bracket

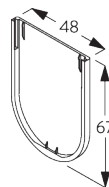

**SG 10574**

Bracket cover

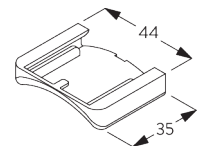

**SG 10575**

Bracket cover



## D. RECESS FITTING

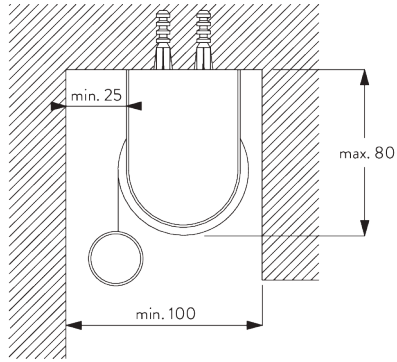

**Brackets**

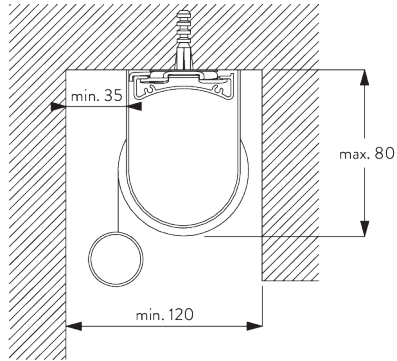

**Installation profile SG 10534 and clamp SG 3044**

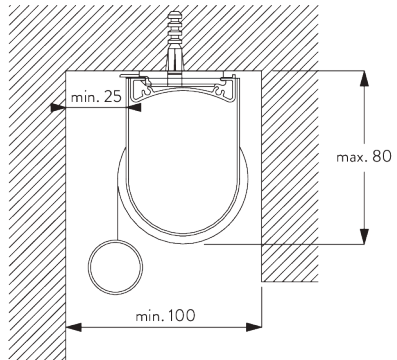

**Installation profile SG 10534 and click bracket SG 10539**

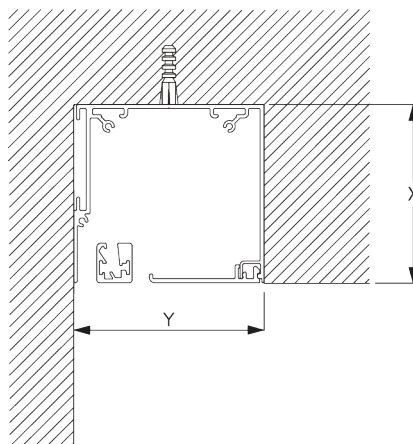

**Box**

X = Box S 73 mm / Box L 110 mm

Y = Box S min. 79 mm / Box L min. 111 mm

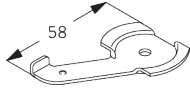

**SG 3044**  
Clamp

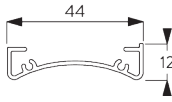

**SG 10534**  
Installation profile

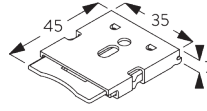

**SG 10539**  
Bracket

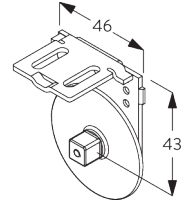

**SG 10542**  
Bracket

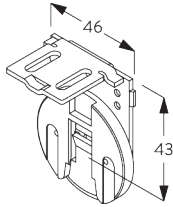

**SG 10543**  
Bracket

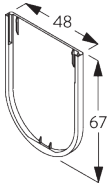

**SG 10574**  
Bracket cover

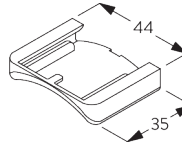

**SG 10575**  
Bracket cover

**E. FITTING WITH  
SIDE GUIDE  
OPTION**

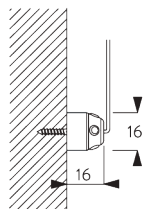
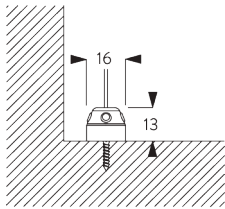

**Single system**

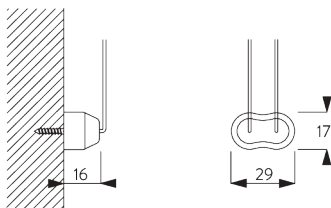
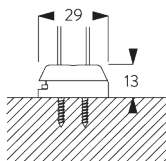

**Double system (side-by-side installation)**

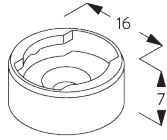

**SG 8235**  
Side guide wire base short

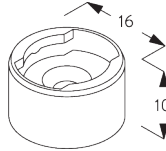

**SG 8236**  
Side guide wire base long

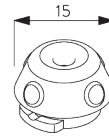

**SG 8237**  
Side guide wire holder

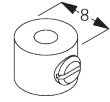

**SG 8249**  
Side guide device

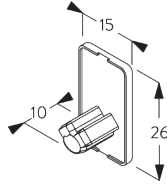

**SG 10636**  
Side guide end cover square

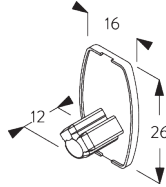

**SG 10638**  
Side guide end cover oval

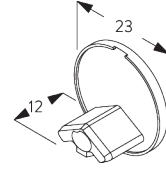

**SG 10640**  
Side guide end cover round

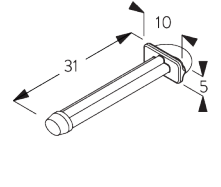

**SG 10641**  
Side guide eyelet

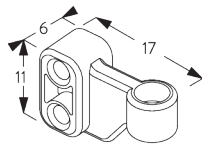

**SG 10642**  
Side guide wire holder

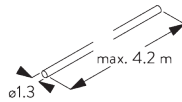

**SG 10643**  
Side guide wire  $\varnothing$  1.2 mm x 4.2 m

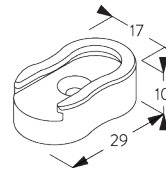

**SG 10669**  
Side guide double base long

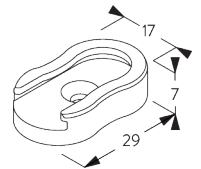

**SG 10673**  
Side guide double base short

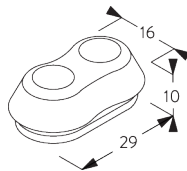

**SG 10701**  
Side guide double wire holder

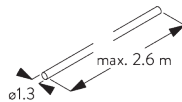

**SG 10706**  
Side guide wire  $\varnothing$  1.3 mm x 2.6 m

## SYSTEM OPTIONS

### A. FABRIC ROLL-OFF

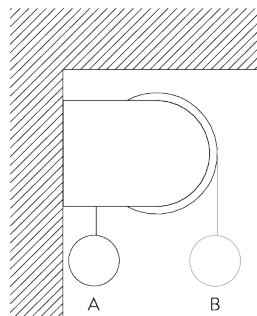
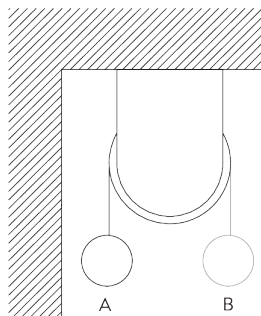

A: Fabric roll-off window side (standard)  
B: Fabric roll-off room side (option)

## **B. INSTALLATION PROFILE**

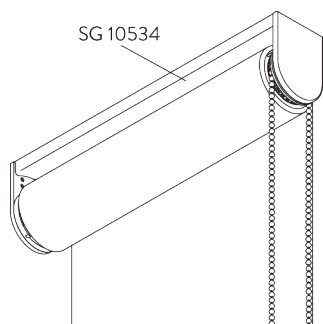

## **C. ADJUSTABLE END STOP**

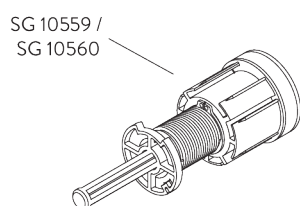

Setting of upper or lower end position.

## **D. SIDE GUIDES**

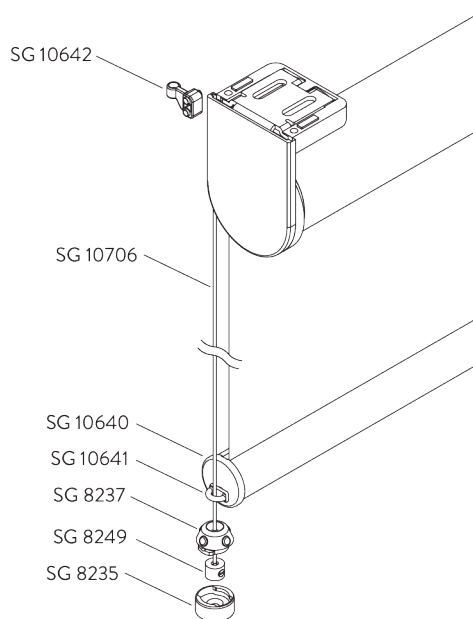

Additional parts:

- 2x SG 8235 Side guide wire base short
- 2x SG 8237 Side guide wire holder
- 2x SG 8249 Side guide device
- 2x SG 10640 Side guide end cover
- 2x SG 10641 Side guide eyelet
- 2x SG 10642 Side guide wire holder
- 2x SG 10706 Side guide wire  $\varnothing$  1.3 mm x 2.6 m

Optional parts:

- 2x SG 8236 Side guide wire base long
- 2x SG 10636 Side guide end cover square
- 2x SG 10638 Side guide end cover oval
- 2x SG 10643 Side guide wire  $\varnothing$  1.2 mm x 4.2 m
- 1x SG 10669 Side guide double base long
- 1x SG 10673 Side guide double base short
- 1x SG 10701 Side guide double wire holder

Note:

- Light gaps increase when side-guide option is used
- Up to 15° from vertical

**E. TWO SINGLE  
SYSTEMS SIDE-BY-  
SIDE**

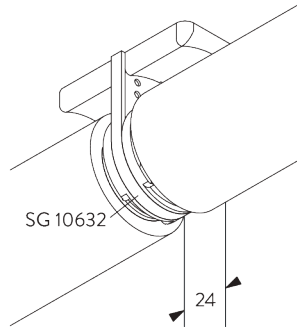

Additional parts:

- 1x SG 10632 Connection bracket cover

**F. CHILD SAFETY**

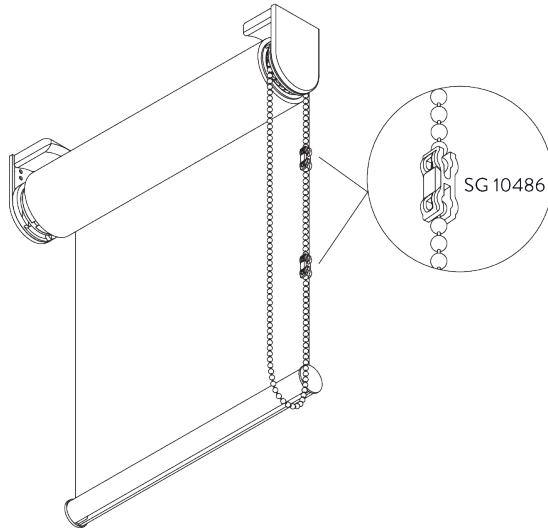

The chain break connector SG 10486 releases the chain should the pulling force exceed 6 kg.

Note:

- System to be installed so chain loop ends at least 60 cm above floor.

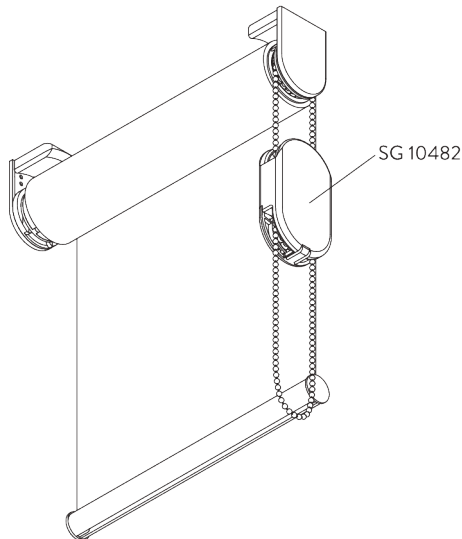

The child safety device SG 10482 releases the chain should the pulling force exceed 6 kg.

Note:

- System to be installed so chain loop of child safety device ends at least 60 cm above floor.

## **G. FASCIA / BOX**

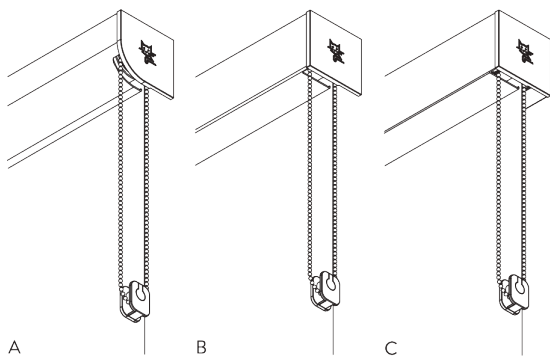

A: Fascia round

B: Fascia square

C: Box

Size:

- S: 78 x 73 mm

- L: 110 x 110 mm

Note:

- Only applicable with bottom bar SG 11442

# GENERAL NOTES

## **Dimensions**

- Measurements are in mm except where indicated.
- Max. kg relates to fabric incl. accessories (bottom bars, etc.).

## **Fitting**

- Installation by qualified fitter only.
- Number of brackets and fitting positions / fixing points vary depending on fitting surface, system weight, fabric make-up, screw / fixing type and obstacles.
- Qualified fitter must use appropriate screws / fixings for each situation.
- Profile lip if applicable to be installed to room side.
- Electrical installations must be carried out according to Silent Gliss wiring diagrams and conform to local regulations.
- Check space for cables and plugs!

## **Child Safety**

- All relevant Silent Gliss systems correspond to child safety EN 13120.
- All parties involved must comply with EN 13120.

# PARTS

## A. STANDARD PARTS



**SG 4221**  
Bottom bar

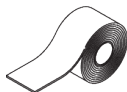

**SG 4226**  
Double tape 30 mm



**SG 10530**  
Bead chain metal  $\varnothing$  4 mm



**SG 10531**  
Tube  $\varnothing$  41 mm

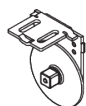

**SG 10542**  
Bracket

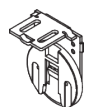

**SG 10543**  
Bracket

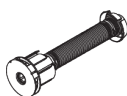

**SG 10553**  
Spring C right, 641 mm

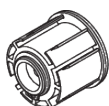

**SG 10556**  
Tube adapter



**SG 10574**  
Bracket cover

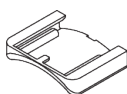

**SG 10575**  
Bracket cover



**SG 10639**  
End cover round

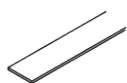

**SG 10668**  
PVC strip 10 mm



**SG 10731**  
Child safety retainer set

## B. OPTIONAL PARTS



**SG 3044**  
Clamp



**SG 8235**  
Side guide wire base short



**SG 8236**  
Side guide wire base long



**SG 8237**  
Side guide wire holder



**SG 8249**  
Side guide device

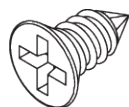

**SG 10139**  
Countersunk screw 2.9x6.5

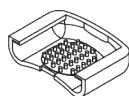

**SG 10387**  
Design bracket cover

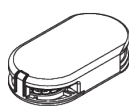

**SG 10482**  
Child safety device set metal chain  $\varnothing$  4.0 mm

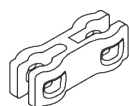

**SG 10486**  
Child safety chain break connector set

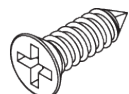

**SG 10498**  
Countersunk screw 2.9x9.5

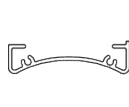

**SG 10534**  
Installation profile



**SG 10535**  
Design end cover

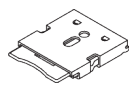

**SG 10539**  
Bracket



**SG 10545**  
Spring A left, 420 mm



**SG 10546**  
Spring B left, 487 mm

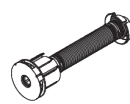

**SG 10547**  
Spring C left, 641 mm



**SG 10548**  
Spring D left, 721 mm

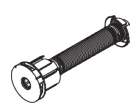

**SG 10549**  
Spring E left, 824 mm

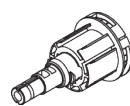

**SG 10550**  
Chain drive

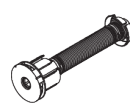

**SG 10551**  
Spring A right, 420 mm



**SG 10552**  
Spring B right, 487 mm

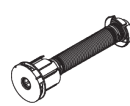

**SG 10554**  
Spring D right, 721 mm

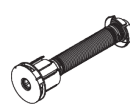

**SG 10555**  
Spring E right, 824 mm

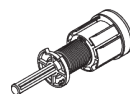

**SG 10559**  
End stop left threads

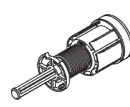

**SG 10560**  
End stop right threads



**SG 10632**  
Connection bracket cover

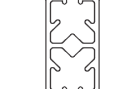















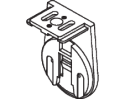





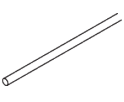

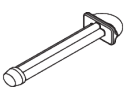
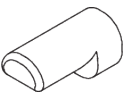

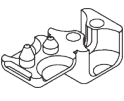

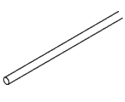
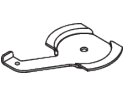
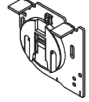

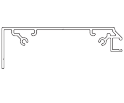
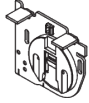

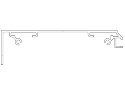
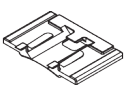
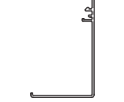

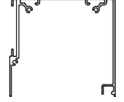
**SG 10633**  
Bottom bar



**SG 10634**  
Bottom bar



	<b>SG 10635</b> End cover square		<b>SG 10700</b> Spring G right, 921 mm		<b>SG 11438</b> Bracket cover round right 73 mm
	<b>SG 10636</b> Side guide end cover square		<b>SG 10701</b> Side guide double wire holder		<b>SG 11439</b> Bracket cover square left 73 mm
	<b>SG 10637</b> End cover oval		<b>SG 10703</b> Design bracket		<b>SG 11440</b> Bracket cover square right 73 mm
	<b>SG 10638</b> Side guide end cover oval		<b>SG 10704</b> Design bracket		<b>SG 11442</b> Bottom bar
	<b>SG 10640</b> Side guide end cover round		<b>SG 10706</b> Side guide wire ø 1.3 mm x 2.6 m		<b>SG 11443</b> End cover
	<b>SG 10641</b> Side guide eyelet		<b>SG 10707</b> End stop		<b>SG 11446</b> Bracket left 73 mm
	<b>SG 10642</b> Side guide wire holder		<b>SG 10709</b> Chain stop for ø 4 mm chain		<b>SG 11447</b> Bracket right 73 mm
	<b>SG 10643</b> Side guide wire ø 1.2 mm x 4.2 m		<b>SG 11180</b> Clamp		<b>SG 11448</b> Bracket left 73 mm
	<b>SG 10669</b> Side guide double base long		<b>SG 11430</b> Installation profile fascia 73 mm		<b>SG 11449</b> Bracket right 73 mm
	<b>SG 10673</b> Side guide double base short		<b>SG 11431</b> Fascia round 73 mm		<b>SG 11530</b> Installation profile fascia 110 mm
	<b>SG 10690</b> Spacer		<b>SG 11432</b> Fascia square 73 mm		<b>SG 11531</b> Fascia round 110 mm
	<b>SG 10697</b> Spring F left, 921 mm		<b>SG 11433</b> Box case 73 mm		<b>SG 11532</b> Fascia square 110 mm
	<b>SG 10698</b> Spring G left, 921 mm		<b>SG 11434</b> Box cover 73 mm		<b>SG 11533</b> Box case 110 mm
	<b>SG 10699</b> Spring F right, 921 mm		<b>SG 11437</b> Bracket cover round left 73 mm		<b>SG 11534</b> Box cover 110 mm



---

**SG 11537**

---

*Bracket cover round left 110 mm*

---



---

**SG 11538**

---

*Bracket cover round right 110 mm*

---

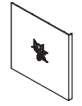

---

**SG 11539**

---

*Bracket cover square left 110 mm*

---



---

**SG 11540**

---

*Bracket cover square right 110 mm*

---

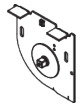

---

**SG 11546**

---

*Bracket left 110 mm*

---



---

**SG 11547**

---

*Bracket right 110 mm*

---

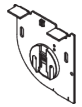

---

**SG 11548**

---

*Bracket left 110 mm*

---



---

**SG 11549**

---

*Bracket right 110 mm*

---



