

SG 2345

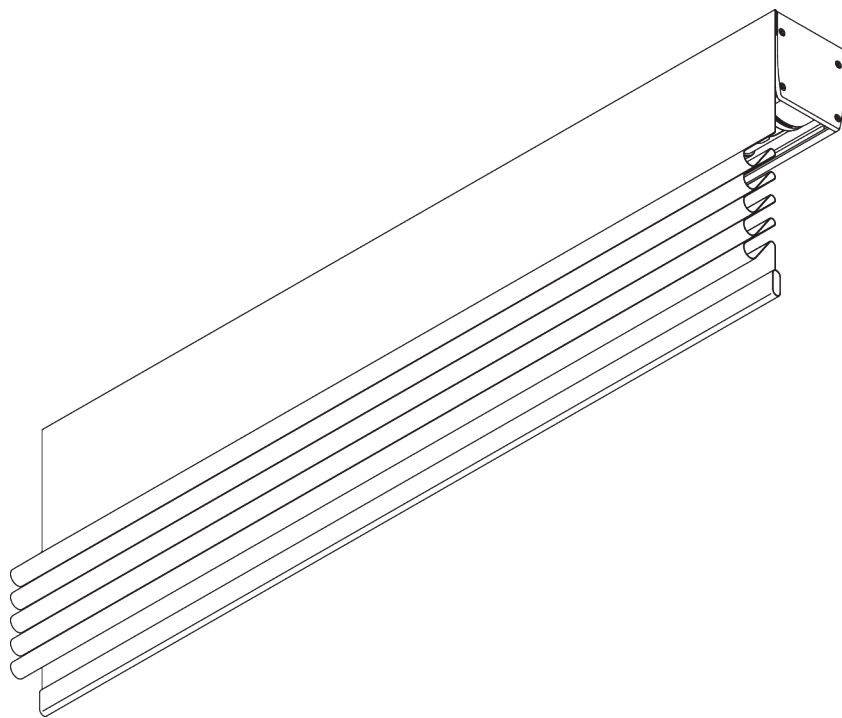
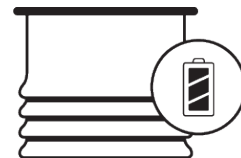

PRODUCT INFORMATION

- **Operation:** motorised (battery operated)
- **Range:** S - M
- **Fitting:** ceiling, wall
- **Colours:** white RAL 9016
- **Fabrics:** refer to Silent Gliss fabric collection

Features:

- Various control options
- Easy exchange of batteries
- Enclosed headrail

SYSTEM SPECIFICATIONS

A. SYSTEM DIMENSIONS



6 m

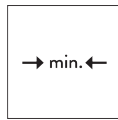

60 cm

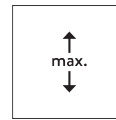

6 m



2.5 kg

B. PROFILE

Profile information

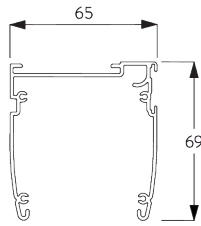

SG 2351

Profile

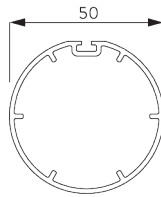

SG 2352

Profile ø 50 mm

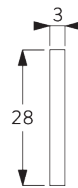

SG 2006

Bottom bar 28x3 mm



SG 2135

Rod steel ø 3 mm

C. HOW TO MEASURE

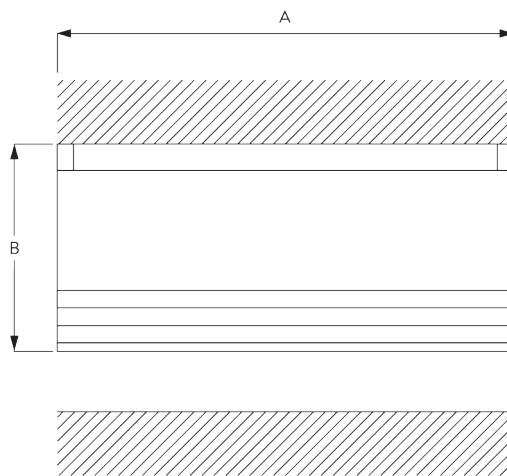

A: System width
B: System height

D. SPECIFICATION TEXT

Silent Gliss SG 2345 Battery Operated Roman Blind System. Ready-assembled comprising aluminium headbox SG 2351 made to measure powder coated in white finish with bonded hook and loop insert, winding tube SG 2352, lift cord SG 2216 and lift cord release mechanism SG 2353 / SG 2354. Ceiling/face fix using universal bracket SG 2363 / wall fix with Silent Gliss Smart Fix bracket range in conjunction with SG 2521 bracket. Integral motor SG 11076 and battery pack SG 11077 with 8 no. lithium batteries SG 11099. Supplied as standard with radio wall transmitter SG 10949. If supplied with made up blind from Silent Gliss fabric collection includes child safe breakaway components SG 31624 bottom bar set, SG 3069 rod cover (hard / semi hard fold makeup), SG 3165 / 3166 ring (soft fold make-up). Compliant to Child Safety legislation EN 13120

FITTING

A. FITTING INFORMATION

For detailed fitting information, visit the [Silent Gliss website](#).

Fixing points

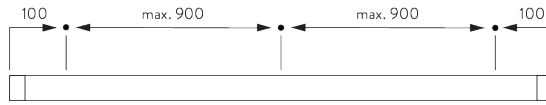

B. CEILING FITTING

Clamp SG 3003

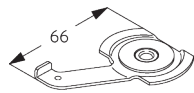
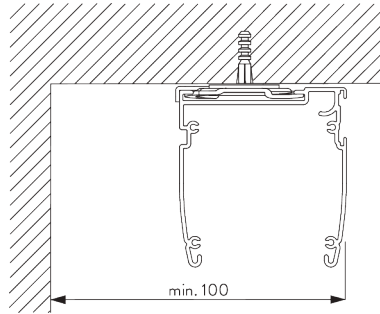

SG 3003
Clamp

Bracket SG 2521

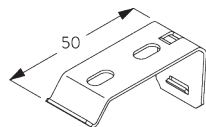
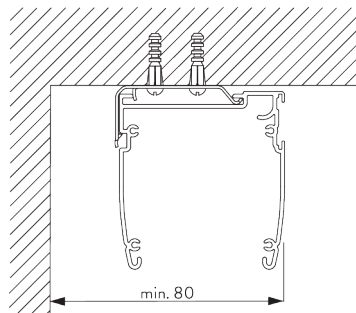

SG 2521
Bracket

C. WALL FITTING

Bracket SG 2363

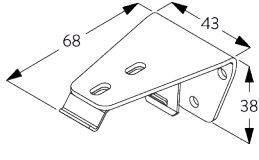
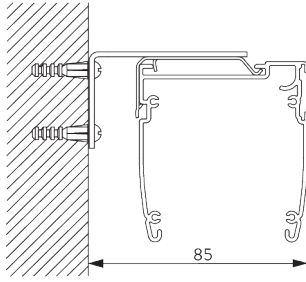

SG 2363

Bracket 68 mm

Smart Fix

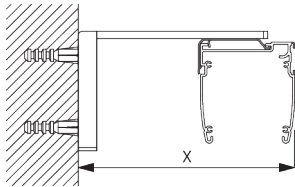

Smart Fix SG 11200 - SG 11204 and bracket SG 2521:
Screw SG 10395 (M4x6) needed.

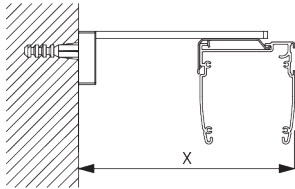

Square Smart Fix SG 11210 - SG 11214 and bracket SG 2521:
Screw SG 10395 (M4x6) needed.

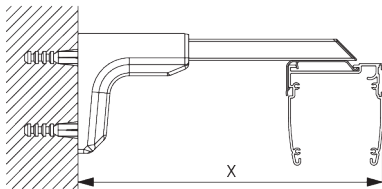

Universal Smart Fix SG 11154 - SG 11156 and bracket SG 2521:
Screw SG 10492 (M4x8) needed.

Smart Fix	X mm
SG 11200 / SG 11210	80-84
SG 11201 / SG 11211	100-104
SG 11202 / SG 11212	120-124
SG 11203 / SG 11213	140-144
SG 11204 / SG 11214	170-174
SG 11154	134-162
SG 11155	164-192
SG 11156	214-242

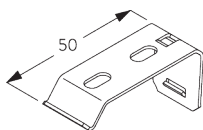

SG 2521
Bracket



SG 10395
Pan head screw M4x6



SG 10492
Pan head screw M4x8

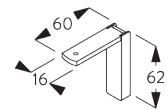

SG 11200
Smart Fix 60 mm

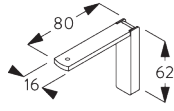

SG 11201
Smart Fix 80 mm

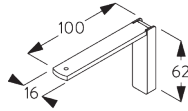

SG 11202
Smart Fix 100 mm

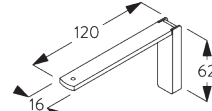

SG 11203
Smart Fix 120 mm

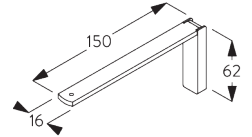

SG 11204
Smart Fix 150 mm

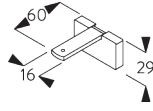

SG 11210
Square Smart Fix 60 mm

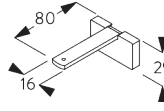

SG 11211
Square Smart Fix 80 mm

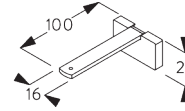

SG 11212
Square Smart Fix 100 mm

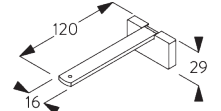

SG 11213
Square Smart Fix 120 mm

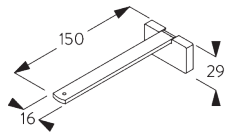

SG 11214
Square Smart Fix 150 mm

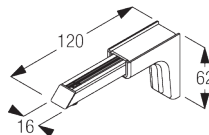

SG 11154
Universal Smart Fix 120 mm

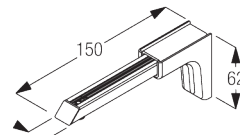

SG 11155
Universal Smart Fix 150 mm

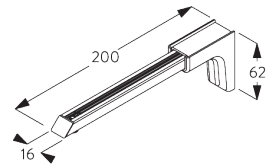

SG 11156
Universal Smart Fix 200 mm

SYSTEM OPTIONS

A. FABRIC MAKE-UP

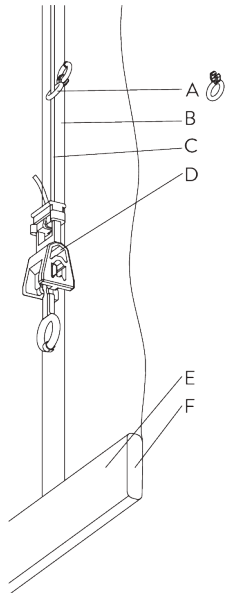

Type A - Softfold

- A: Child safety tape set SG 3166
- B: Set includes tape and child safety eyelet
- C: Tape SG 2163
- D: Child safety hook set SG 3164
- E: Hollow hem
- F: Bottom bar SG 2005

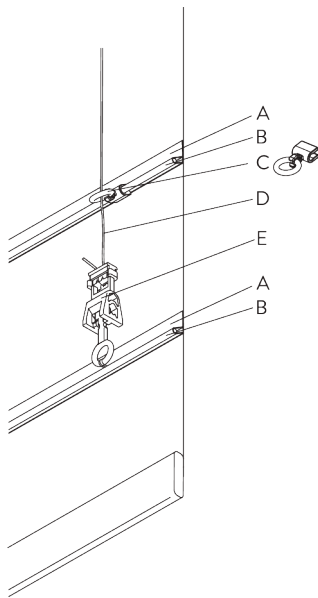

Type B - Hardfold

- A: Tape SG 2136
- B: Rod SG 2135
- C: Child safety eyelet hard fold SG 3069
- D: Tape SG 2163
- E: Child safety hook set SG 3164

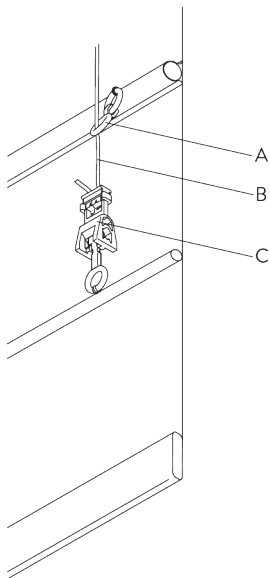

Type C - Hardfold

- A: Child safety eyelet set SG 3165
- B: Tape SG 2163
- C: Child safety hook set SG 3164

B. BATTERY EXCHANGE

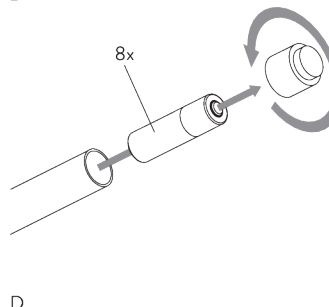
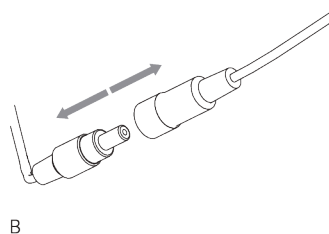
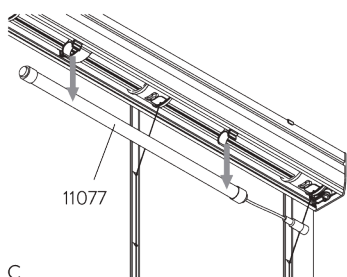
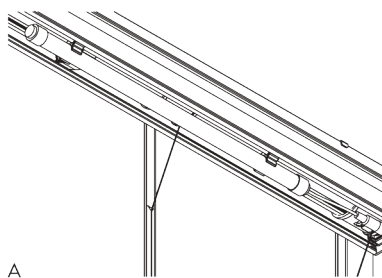

MOTOR & CONTROLS

A. MOTOR FEATURES

Motor	SG 11076
Motor Features	
Soft start / stop	●
Built-in receiver	●
Electronic end-stop	●
Electronic revolution counter (unlimited revolution)	●
IP class	IP 44
Control Features	
SG Control A	●

B. MOTOR SPECIFICATIONS

Motor	Min. system width	Voltage	Current	Speed	Frequency receiver
SG 11076	60 cm	12 V DC	0.55 A	30 rpm	433 MHz

C. OPERATION METHODS

See catalogue "controls" for details.

SG Control A



Various radio hand-held and wall transmitters available.

GENERAL NOTES

Dimensions

- Measurements are in mm except where indicated.
- Max. kg relates to fabric incl. accessories (bottom bars, cross rods, etc.).
- Stack size is typically 15-20% of system height.

Fitting



- Installation by qualified fitter only.
- Number of brackets and fitting positions / fixing points vary depending on fitting surface, system weight, fabric make-up, screw / fixing type and obstacles.
- Qualified fitter must use appropriate screws / fixings for each situation.
- Electrical installations must be carried out according to Silent Gliss wiring diagrams and conform to local regulations.
- Check space for cables and plugs!

Child Safety



- All relevant Silent Gliss systems correspond to child safety EN 13120.
- All parties involved must comply with EN 13120.

PARTS

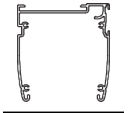
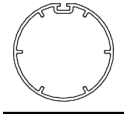
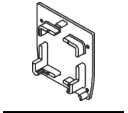
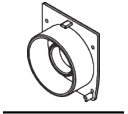
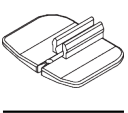
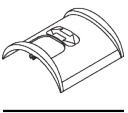
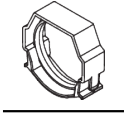
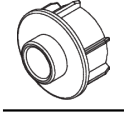
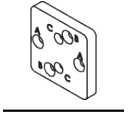
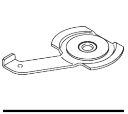
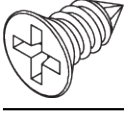
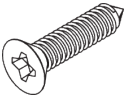
A. STANDARD PARTS

	SG 2216 Cord ø 0.85 mm
	SG 2221 Velcro tape
	SG 2351 Profile
	SG 2352 Profile ø 50 mm
	SG 2353 End cover
	SG 2354 End cover
	SG 2357 Pin
	SG 2358 Shell
	SG 2359 Support
	SG 2361 Tube adapter
	SG 2368 Motor plate
	SG 3003 Clamp
	SG 10139 Countersunk screw 2.9x6.5
	SG 10467 Countersunk head screw 2.9x13

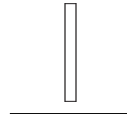
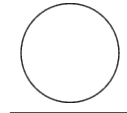
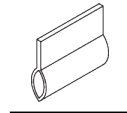
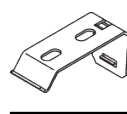
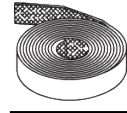
B. OPTIONAL PARTS

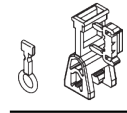
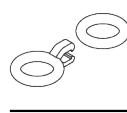
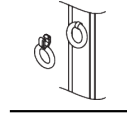
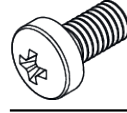
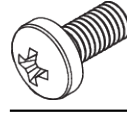
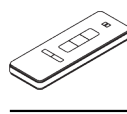
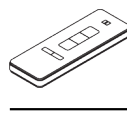
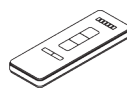
	SG 2006 Bottom bar 28x3 mm
	SG 2135 Rod steel ø 3 mm
	SG 2136 Rod tape
	SG 2521 Bracket
	SG 2539 Tape
	SG 3069 Child safety eyelet
	SG 3164 Child safety hook set
	SG 3165 Child safety eyelet set
	SG 3166 Child safety tape set
	SG 10395 Pan head screw M4x6
	SG 10492 Pan head screw M4x8
	SG 10946 Radio hand held 1 channel
	SG 10947 Radio hand held 2+1 channel
	SG 10948 Radio hand held 6+1 channel



SG 10950
Radio wall transmitter 2 channel



SG 10951
Radio wall transmitter 5+1 channel

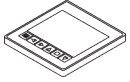

SG 11093
Radio timer unit 16 channel

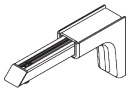

SG 11154
Universal Smart Fix 120 mm

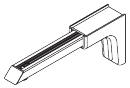

SG 11155
Universal Smart Fix 150 mm

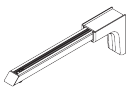

SG 11156
Universal Smart Fix 200 mm

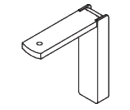

SG 11200
Smart Fix 60 mm

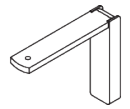

SG 11201
Smart Fix 80 mm

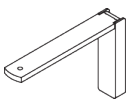

SG 11202
Smart Fix 100 mm

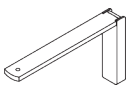

SG 11203
Smart Fix 120 mm

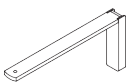

SG 11204
Smart Fix 150 mm

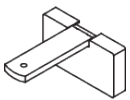

SG 11210
Square Smart Fix 60 mm

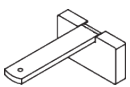

SG 11211
Square Smart Fix 80 mm

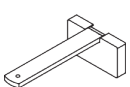

SG 11212
Square Smart Fix 100 mm

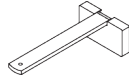

SG 11213
Square Smart Fix 120 mm

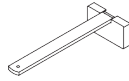

SG 11214
Square Smart Fix 150 mm



SG 11429
Radio timer unit 1 channel

