

SG 2810

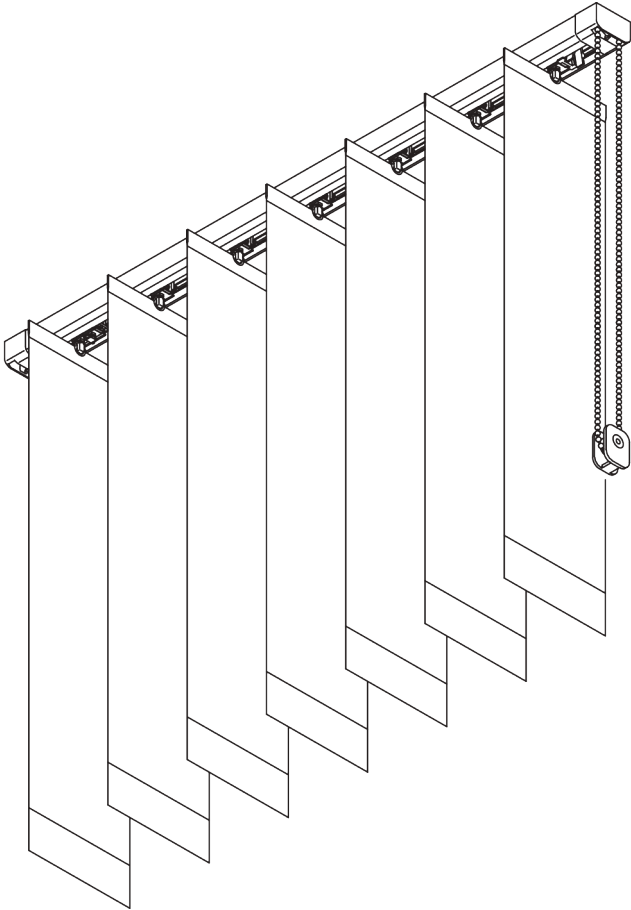
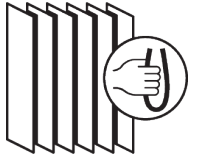

PRODUCT INFORMATION

- **Operation:** chain
- **Range:** S - M
- **Fitting:** ceiling, wall, recess
- **Colours:** white RAL 9016 or anodised aluminum, special colours possible
- **Fabrics:** refer to Silent Gliss fabric collection

Features:

- Optimised light control
- Mono controlled
- Pull override protection
- Louvre width: 127 mm (standard), 89 mm
- Vertical Waves
- Bendable

09/2021/V1

SYSTEM SPECIFICATIONS

A. SYSTEM DIMENSIONS



127 mm louvres: 5 m
89 mm louvres: 3.8 m

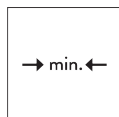

40 cm



4 m



200 g per louvre

Max. system widths

	127 mm 89 mm	5 m 3.8 m
	127 mm 89 mm	4 m 3.1 m
	127 mm 89 mm	4 m 3.1 m

Stack sizes

		100	150	200	250	300	350	400	450	500
127 mm		27	35	42	50	57	65	72	80	87
		21	25	28	32	36	39	43	47	50
89 mm		29	40	50	60	69	80			
		20	25	30	35	39	45			

(cm)

B. PROFILE

Profile and bending information

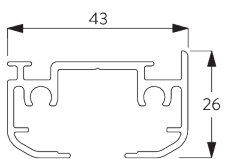

SG 2601
Profile

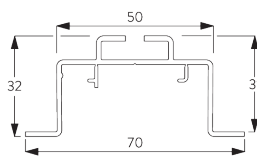

SG 2614
Recess profile

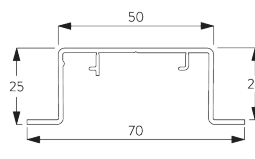

SG 2615
Recess profile

Radius:
>75 cm

**C. HOW TO
MEASURE**

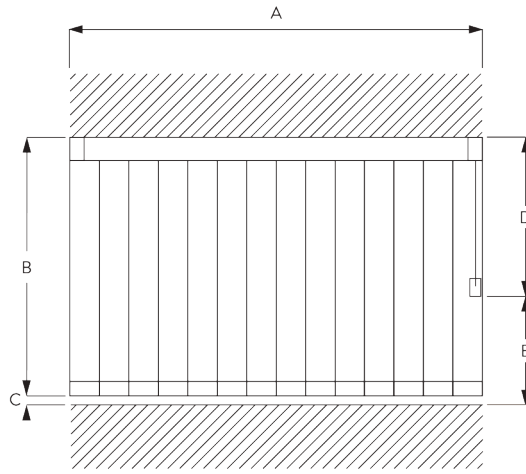

- A: System width
- B: System height
- C: Distance between floor and fabric
- D: Chain height
- E: Safety retainer SG 10731 min. 150 cm above floor

Light gap

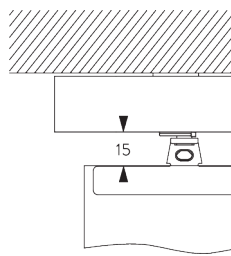

**D. SPECIFICATION
TEXT**

Silent Gliss SG 2810 Chain Operated Vertical Blind System. Comprises aluminium profile SG 2601 supplied made to measure powder coated white or silver anodised. Assembled complete with mono control chain SG 2872 and rotation elements to suit louvre width 127mm SG 2623 / 89mm SG 2625. Top fixed with clamp SG 2616 at max 300mm centres + 1. Wall fixed with bracket SG 2616 in conjunction with SG Smart Fix brackets SG 11201-11204 / SG Square Smart Fix brackets SG 11211-11214 / SG Universal Smart Fix brackets SG 11154-11156 at 300mm centres + 1. Recess fixed option with recess profile SG 2614 and wedges SG 5118. Fabric supplied from Silent Gliss fabric range.

FITTING

**A. FITTING
INFORMATION**

For detailed fitting information, visit the Silent Gliss website.

Fixing points

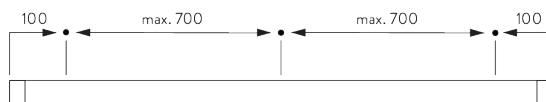

B. CEILING FITTING

Bracket SG 2616

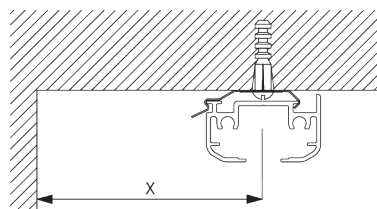

Min. wall distance louvres	X mm
89 mm	65
127 mm	85
Vertical Waves 89 mm	115
Vertical Waves 125 mm	140

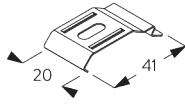

SG 2616
Bracket

C. RECESS FITTING

Recess profile SG 2615

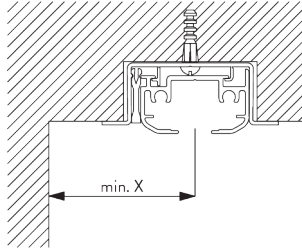

Recess profile SG 2615 can not be bent!
One wedge SG 5118 per fixing point.
For detailed recess fitting, visit the Silent Gliss website.

Min. wall distance louvres	X mm
89 mm	65
127 mm	85
Vertical Waves 89 mm	115
Vertical Waves 125 mm	140

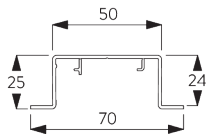

SG 2615
Recess profile

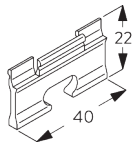

SG 5118
Wedge

Suspended ceiling / recess profile SG 2614 and hanger SG 6268

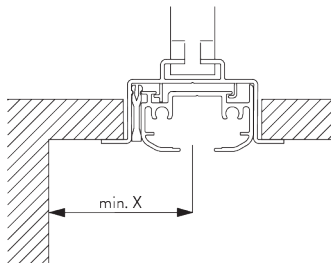

Recess profile SG 2614 can not be bent!
One wedge SG 5118 per fixing point.
For detailed recess fitting, visit the Silent Gliss website.

Min. wall distance louvres	X mm
89 mm	65
127 mm	85
Vertical Waves 89 mm	115
Vertical Waves 125 mm	140

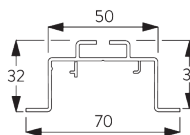

SG 2614
Recess profile

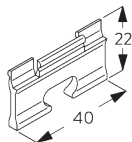

SG 5118
Wedge

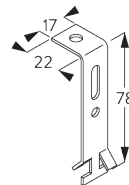

SG 6268
Hanger

D. WALL FITTING

Smart Fix

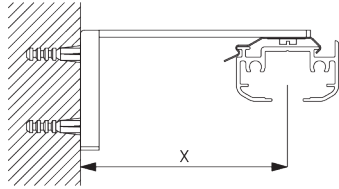

Smart Fix SG 11201 - SG 11204 and bracket SG 2616:
Screw SG 10395 (M4x6) needed

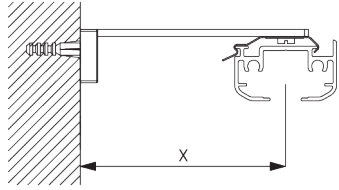

Square Smart Fix SG 11211 - SG 11214 and bracket SG 2616:
Screw SG 10395 (M4x6) needed

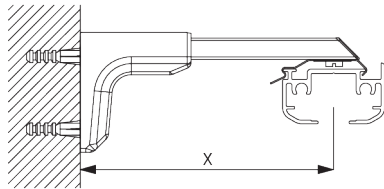

Universal Smart Fix SG 11154 - SG 11156 and bracket SG 2616:
Screw SG 10492 (M4x8) needed

Smart Fix	X mm
SG 11201 / SG 11211	72
SG 11202 / SG 11212	92
SG 11203 / SG 11213	112
SG 11204 / SG 11214	142
SG 11154	102-130
SG 11155	132-160
SG 11156	182-210
Min. wall distance louvres	
89 mm	65
127 mm	85
Vertical Waves 89 mm	115
Vertical Waves 125 mm	140

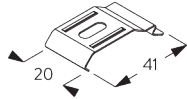

SG 2616
Bracket



SG 10395
Pan head screw M4x6



SG 10492
Pan head screw M4x8

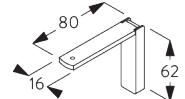

SG 11201
Smart Fix 80 mm

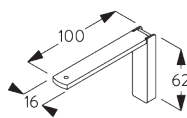

SG 11202
Smart Fix 100 mm

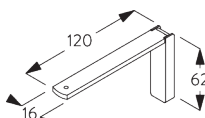

SG 11203
Smart Fix 120 mm

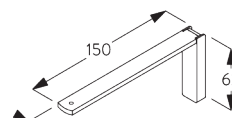

SG 11204
Smart Fix 150 mm

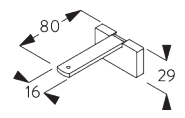

SG 11211
Square Smart Fix 80 mm

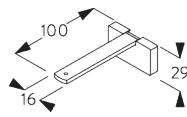

SG 11212
Square Smart Fix 100 mm

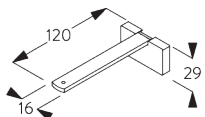

SG 11213
Square Smart Fix 120 mm

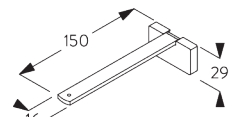

SG 11214
Square Smart Fix 150 mm

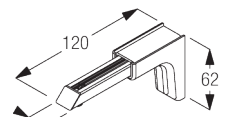

SG 11154
Universal Smart Fix 120 mm

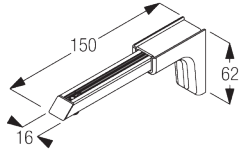

SG 11155
Universal Smart Fix 150 mm

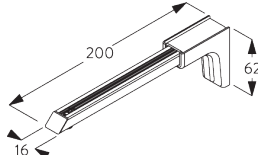

SG 11156
Universal Smart Fix 200 mm

SYSTEM OPTIONS

A. VERTICAL WAVES

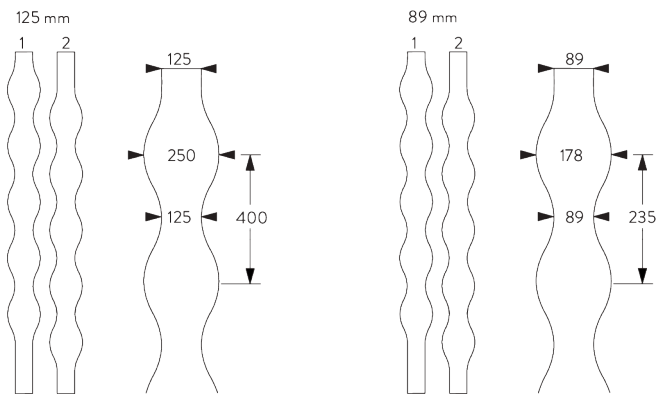
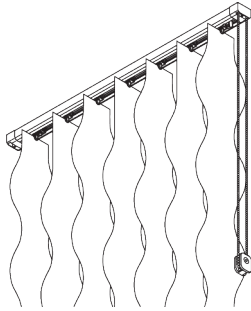

3D Vertical Waves only applicable with 125 mm louvres.

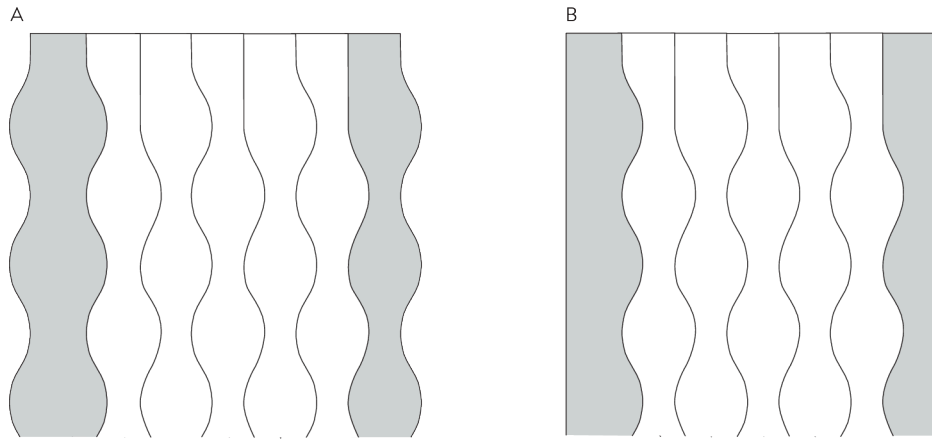

Wall ending

A: Wavy edge

B: Straight edge

B. STACKING **VARIATIONS**

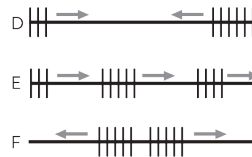
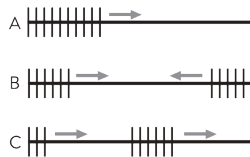

A: Single stack in one direction

B: Pair stack in two directions symmetrical

C: Pair stack in one direction asymmetrical

D: Pair stack in two directions asymmetrical

E: Multiple stacking in one direction symmetrical or asymmetrical

F: Centre stack

GENERAL NOTES

Dimensions

- Measurements are in mm except where indicated.
- Max. kg relates to fabric incl. accessories (bottom bars, etc.).
- Recommended distance floor / fabric: 20 mm.
- In order to determine system height (B), the smallest room height must be taken into account.

Fitting

- Installation by qualified fitter only.
- Number of brackets and fitting positions / fixing points vary depending on fitting surface, system weight, fabric make-up, screw / fixing type and obstacles.
- Qualified fitter must use appropriate screws / fixings for each situation.
- Profile lip if applicable to be installed to room side.
- Electrical installations must be carried out according to Silent Gliss wiring diagrams and conform to local regulations.
- Check space for cables and plugs!

Child Safety

- All relevant Silent Gliss systems correspond to child safety EN 13120.
- All parties involved must comply with EN 13120.

PARTS

A. STANDARD PARTS

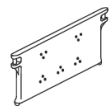

SG 2471

Bottom weight 127 mm



SG 2479

Bottom link 127 mm



SG 2601

Profile

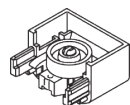

SG 2604

Guide

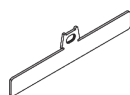

SG 2605

Top clip 127 mm

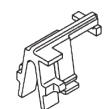

SG 2610

End stop

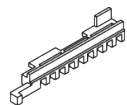

SG 2611

Stopper

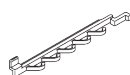

SG 2612

Brake



SG 2616

Bracket

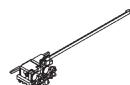

SG 2620

Pilot runner



SG 2623

Rotation element set 127 mm



SG 2624

Rotation element set 100 mm

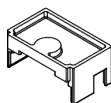

SG 2627

Cover



SG 2865

Bead chain connector ø 4.6 mm



SG 2872

Bead chain plastic ø 4.6 mm



SG 10731

Child safety retainer set

B. OPTIONAL PARTS

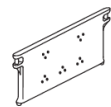

SG 2473

Bottom weight 89 mm



SG 2481

Bottom link 89 mm

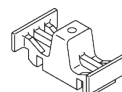

SG 2608

End stop

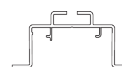

SG 2614

Recess profile

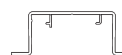

SG 2615

Recess profile



SG 2618

Shaft



SG 2625

Rotation element set 89 mm

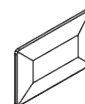

SG 2671

Bottom weight 89 mm

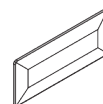

SG 2672

Bottom weight 127 mm

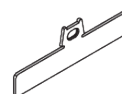

SG 2813

Top clip 89 mm

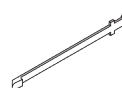

SG 2821

Spacer 63 mm / 2.5"



SG 2888

Bottom link 127 mm / 5"

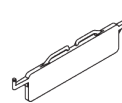

SG 2892

Bottom weight 127 mm / 5"

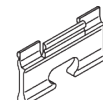

SG 5118

Wedge

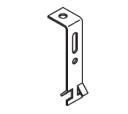

SG 6268

Hanger



SG 10395

Pan head screw M4x6



SG 10492

Pan head screw M4x8

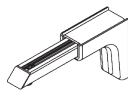

SG 11154

Universal Smart Fix 120 mm

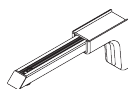

SG 11155

Universal Smart Fix 150 mm



SG 11156

Universal Smart Fix 200 mm

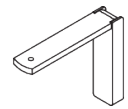

SG 11201

Smart Fix 80 mm

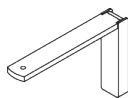

SG 11202

Smart Fix 100 mm

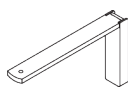

SG 11203

Smart Fix 120 mm

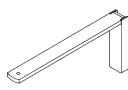

SG 11204

Smart Fix 150 mm

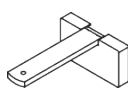

SG 11211

Square Smart Fix 80 mm

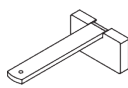

SG 11212

Square Smart Fix 100 mm

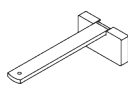

SG 11213

Square Smart Fix 120 mm

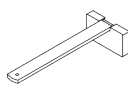

SG 11214

Square Smart Fix 150 mm

