

SG 8910

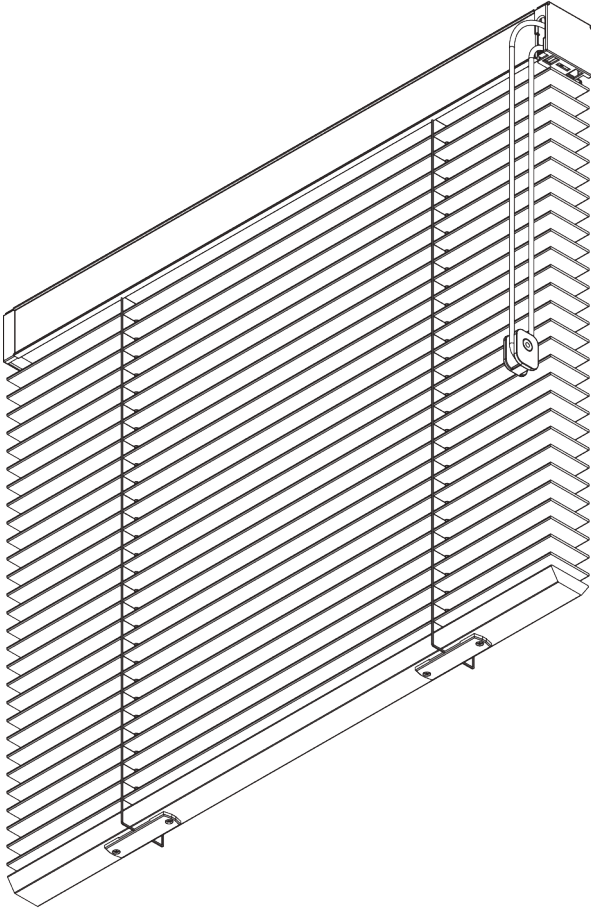
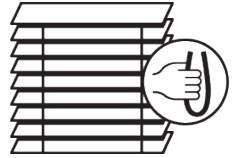

PRODUCT INFORMATION

- **Operation:** cord
- **Range:** L
- **Fitting:** ceiling, wall
- **Colours:** refer to Silent Gliss slat collection

Features:

- Optimised light control
- Speed controller: semi-automatic lowering of slats
- Wood, aluminium and leather slats
- Slat width: 50 mm
- Headrail slat cover
- Choice of ladder cord or decorative slat tape

09/2021/V1

SYSTEM SPECIFICATIONS

A. SYSTEM DIMENSIONS

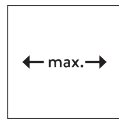

Wood / Leather: 2.4 m
Aluminium: 3.6 m

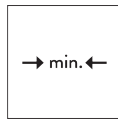

65 cm

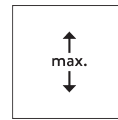

Wood / Leather: 2.75 m
Aluminium: 3.6 m



Wood / Leather: 4.6 m²
Aluminium: 10 m²

Slat stack heights

Note: stack size will be larger when tapes are used

Wooden										
	50 mm	X								
			60	90	120	150	180	210	240	275
			12	15	17	20	22	25	27	30
(cm)										
Leather										
	50 mm	X								
			60	90	120	150	180	210	240	275
			14	16	18	20	22	24	26	28
(cm)										
Aluminium										
	50 mm	X								
			100	200	300	360				
			10	13	17	20				
(cm)										

B. PROFILE

Profile information

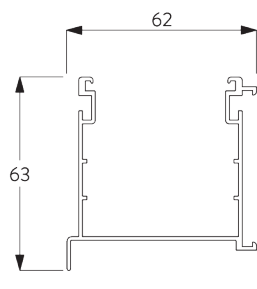

SG 8902

Profile

**C. HOW TO
MEASURE**

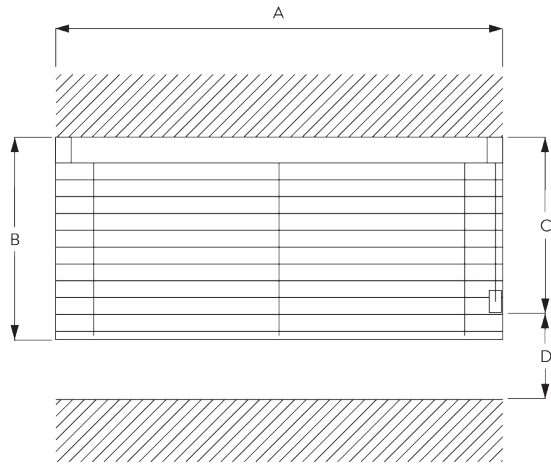

A: System width
 B: System height
 C: Cord height
 D: Safety Retainer SG 10731 min. 150 cm above floor

**D. SPECIFICATION
TEXT**

Silent Gliss SG 8910 Cord Operated Venetian Blind System. Supplied made to measure and complete comprising aluminium headrail SG 8902 incorporating matching colour slat, right or left-hand side single cord operation which permits raising, lowering and tilting of the slats. System fixed with universal brackets SG 8920 to ceiling or wall at 500mm intervals plus one at 100mm from each end. Compliant to Child Safety legislation EN 13120 when used in conjunction with Cord Retainer 10400. Slat colours to be chosen from Silent Gliss 50mm aluminium / wood / leather range.

FITTING

**A. FITTING
INFORMATION**

For detailed fitting information, visit the Silent Gliss website.

Fixing points

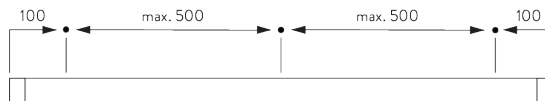

B. CEILING FITTING

Bracket SG 8920

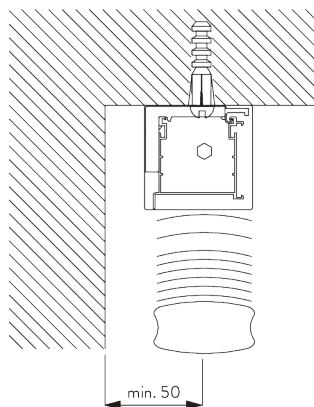

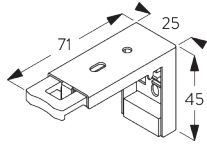

SG 8920

Bracket

C. WALL FITTING

Bracket SG 8920

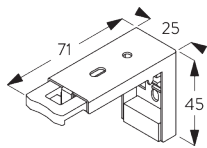
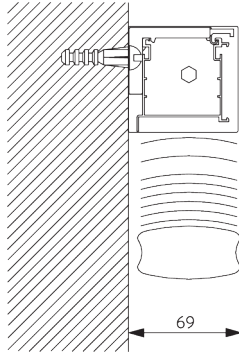

SG 8920

Bracket

**D. FITTING WITH
SIDE GUIDE
OPTION**

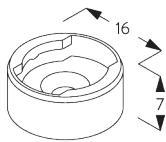
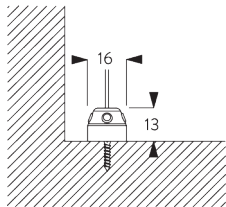

SG 8235

Side guide wire base short

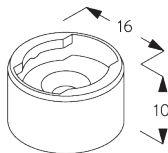

SG 8236

Side guide wire base long

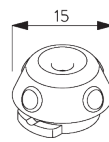

SG 8237

Side guide wire holder

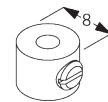

SG 8249

Side guide device

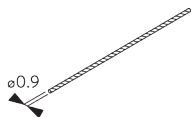

SG 10120

Side guide wire \varnothing 0.9 mm

SYSTEM OPTIONS

A. HEADRAIL SLAT COVER

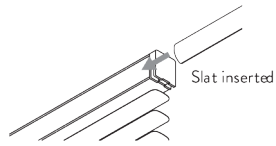

- A slat is inserted into the headrail for perfect matching of colours and materials to avoid the need to fit a cumbersome valance.
- For leather slat blinds there is the option of a leather covered headrail at an additional cost.
- Leather covered slats cannot be specified with decorative (external) slat tapes. The blind hardware is supplied matching the slat colour.

B. SIDE GUIDES

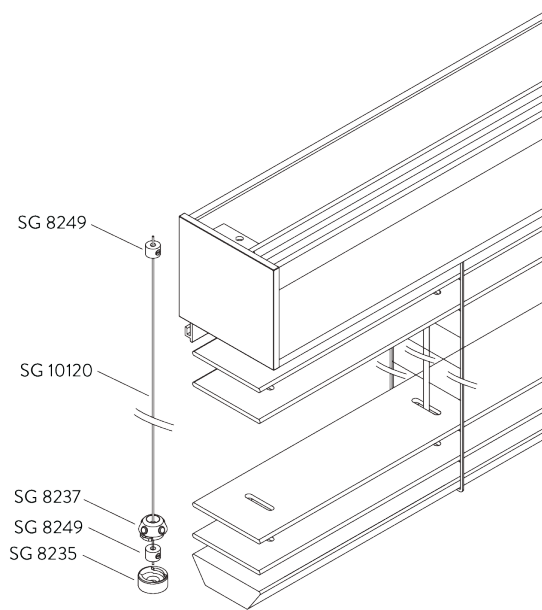

Additional parts:

- 2x SG 8235 Side guide wire base short
- 2x SG 8237 Side guide wire holder
- 4x SG 8249 Side guide device
- 2x SG 10120 Side guide wire \varnothing 0.9 mm

Note:

- Up to 15° from vertical

GENERAL NOTES

Dimensions

- *Measurements are in mm except where indicated.*

Fitting

- *Installation by qualified fitter only.*
- *Number of brackets and fitting positions / fixing points vary depending on fitting surface, system weight, slate type, screw / fixing type and obstacles.*
- *Qualified fitter must use appropriate screws / fixings for each situation.*
- *Profile lip if applicable to be installed to room side.*
- *Electrical installations must be carried out according to Silent Gliss wiring diagrams and conform to local regulations.*
- *Check space for cables and plugs!*

Child Safety

- *All relevant Silent Gliss systems correspond to child safety EN 13120.*
- *All parties involved must comply with EN 13120.*

PARTS

A. STANDARD PARTS

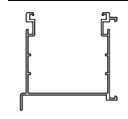

SG 8902

Profile

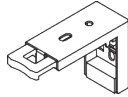

SG 8920

Bracket



SG 10731

Child safety retainer set

B. OPTIONAL PARTS



SG 8235

Side guide wire base short



SG 8236

Side guide wire base long



SG 8237

Side guide wire holder

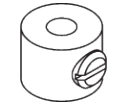

SG 8249

Side guide device



SG 10120

Side guide wire \varnothing 0.9 mm

