

SG 8960

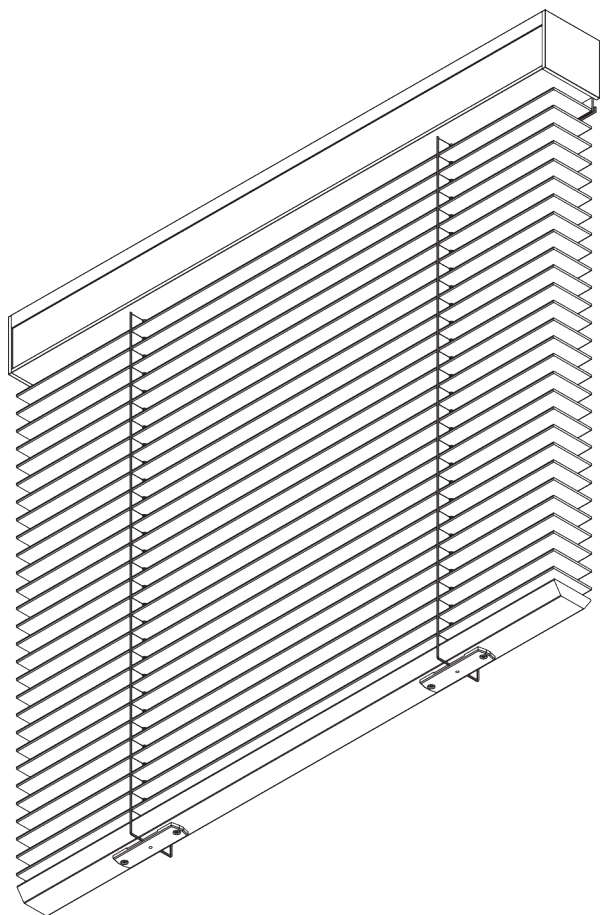
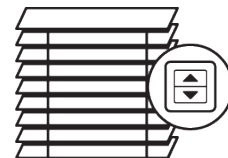

PRODUCT INFORMATION

- **Operation:** motorised
- **Range:** L
- **Fitting:** ceiling, wall
- **Colours:** refer to Silent Gliss slat collection

Features:

- Optimised light control
- Various control options
- Wood, aluminium and leather slats
- Slat width: 50 mm
- Headrail slat cover
- Choice of ladder cord or decorative slat tape

SYSTEM SPECIFICATIONS

A. SYSTEM DIMENSIONS

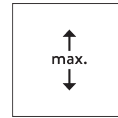
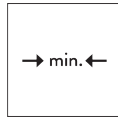
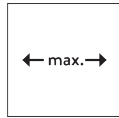

Wood / Leather: 2.4 m
Aluminium: 3.6 m

65 cm

Wood / Leather: 2.75 m
Aluminium: 3.6 m

Wood / Leather: 4.6 m²
Aluminium: 10 m²

Slat stack heights

Note: stack size will be larger when tapes are used

Wooden

	50 mm	X								
			60	90	120	150	180	210	240	275
			12	15	17	20	22	25	27	30

(cm)

Leather

	50 mm	X								
			60	90	120	150	180	210	240	275
			16	18	20	22	24	26	28	30

(cm)

Aluminium

	50 mm	X				
			100	200	300	360
			10	13	17	20

(cm)

B. PROFILE

Profile information

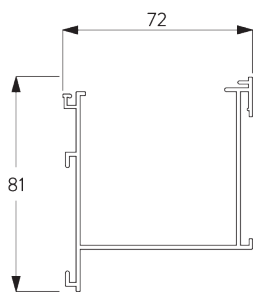

SG 8935
Profile

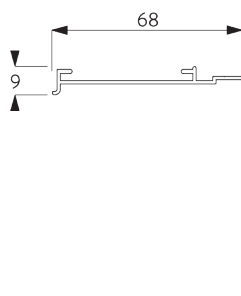

SG 8936
Profile

**C. HOW TO
MEASURE**

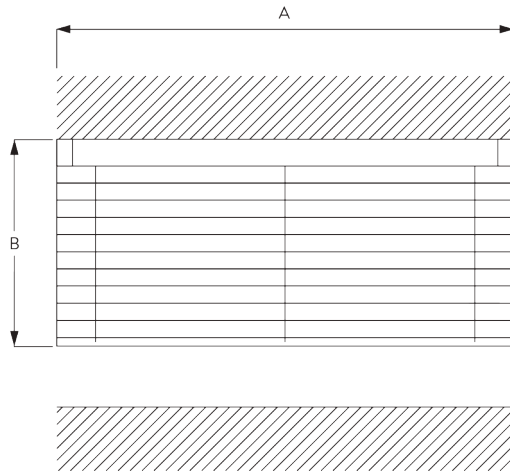

A: System width
B: System height

**D. SPECIFICATION
TEXT**

Silent Gliss SG 8960 Electrically Operated Venetian Blind System. Supplied made to measure and complete comprising aluminium headrail SG 8935 and cover SG 8936 incorporating matching colour slat. System fixed with clamps SG 3033 to ceiling or wall at 450mm intervals plus one at 100mm from each end. Supplied with motor SG 11095 with operation by 5 position switch SG 0613 which permits raising, lowering and tilting of the slats / operation by third party control system subject to suitable interface by others. Optional motor SG 11096 with integrated receiver for use with radio control system SG 9940 (hand, wall mounted transmitters and SG Move app). Can be switched by Silent Gliss SG 0450 radio control system by external receiver. All wireless controls at extra cost. Slat colours to be chosen from Silent Gliss 50mm aluminium / wood / leather range.

FITTING

**A. FITTING
INFORMATION**

For detailed fitting information, visit the Silent Gliss website.

Fixing points

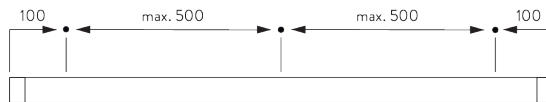

B. CEILING FITTING

Clamp SG 3003

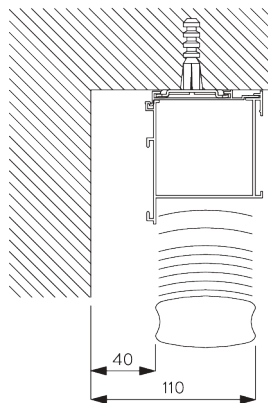

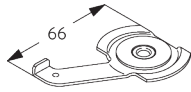

SG 3003

Clamp

C. WALL FITTING

Clamp SG 3003

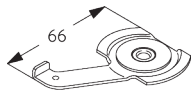
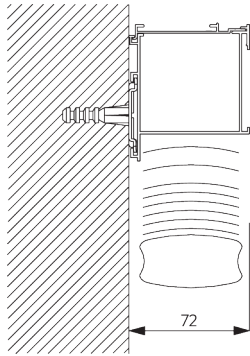

SG 3003

Clamp

**D. FITTING WITH
SIDE GUIDE
OPTION**

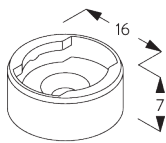
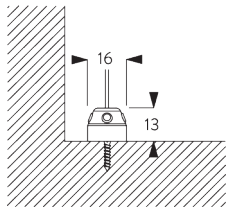

SG 8235

Side guide wire base short

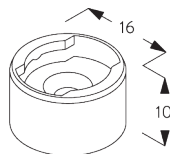

SG 8236

Side guide wire base long

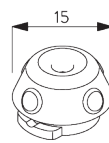

SG 8237

Side guide wire holder

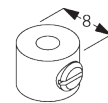

SG 8249

Side guide device

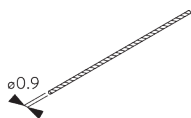

SG 10120

Side guide wire ø 0.9 mm

SYSTEM OPTIONS

A. HEADRAIL SLAT COVER

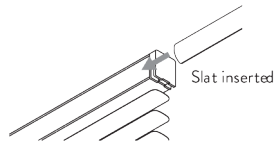

- A slat is inserted into the headrail for perfect matching of colours and materials to avoid the need to fit a cumbersome valance.
- For leather slat blinds there is the option of a leather covered headrail at an additional cost.
- Leather covered slats cannot be specified with decorative (external) slat tapes. The blind hardware is supplied matching the slat colour.

B. SIDE GUIDES

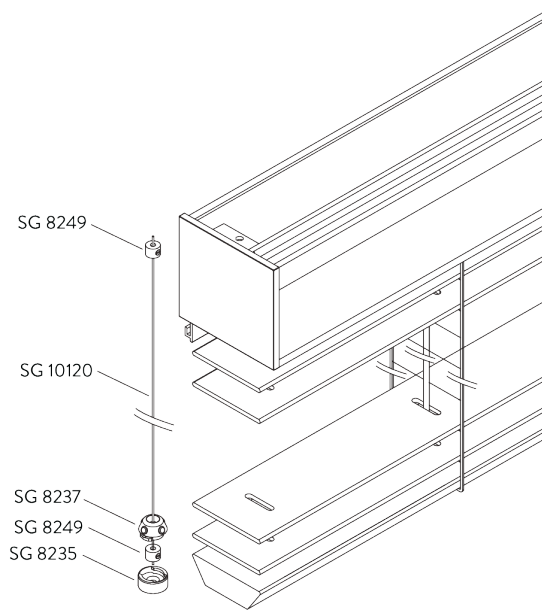

Additional parts:

- 2x SG 8235 Side guide wire base short
- 2x SG 8237 Side guide wire holder
- 4x SG 8249 Side guide device
- 2x SG 10120 Side guide wire \varnothing 0.9 mm

Note:

- Up to 15° from vertical

MOTOR & CONTROLS

A. MOTOR FEATURES

Motors	SG 11095	SG 11096	SG 11328
Motor Features			
Soft start / stop	•	•	
Built-in receiver		•	
Electronic end-stop	•	•	
Electronic revolution counter (unlimited revolution)	•	•	
Mechanical end-stop			•
Mechanical revolution counter (limited revolution)			•
Intermediate positions possible		•	
Noiseless stop	•	•	•
IP class	IP 54	IP 54	IP 44
Control Features			
Mains power control	•		•
SG Control L (built-in receiver)		•	
SG Control L (external receiver required)			•
SG Control R (external receiver required)	•		
Suitable for most major home automation systems (with suitable interface)	•	•	•

B. MOTOR SPECIFICATIONS

Motors	Voltage	Current	Frequency	Speed	Frequency receiver
SG 11095	230 V AC	0.5 A	50 Hz	35 rpm	n/a
SG 11096	230 V AC	0.5 A	50 Hz	35 rpm	868 MHz
SG 11328	120 V AC	1.3 A	60 Hz	30 rpm	n/a

C. OPERATING METHODS

See catalogue "controls" for details.

Wall Switch



System can be operated by fixed wall switch.

SG Control L

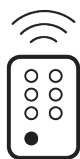

Various radio hand-held and wall transmitters available.



Silent Gliss Move App.

SG Control R



Various radio hand-held and wall transmitters available.
An external receiver is required.

D. WIRING DIAGRAMS



Refer to Silent Gliss website.

GENERAL NOTES

Dimensions

- Measurements are in mm except where indicated.

Fitting

- Installation by qualified fitter only.
- Number of brackets and fitting positions / fixing points vary depending on fitting surface, system weight, slate type, screw / fixing type and obstacles.
- Qualified fitter must use appropriate screws / fixings for each situation.
- Profile lip if applicable to be installed to room side.
- Electrical installations must be carried out according to Silent Gliss wiring diagrams and conform to local regulations.
- Check space for cables and plugs!

Child Safety

- All relevant Silent Gliss systems correspond to child safety EN 13120.
- All parties involved must comply with EN 13120.

PARTS

A. STANDARD PARTS

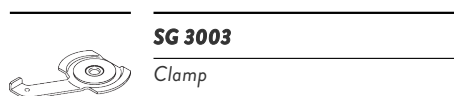

SG 3003

Clamp

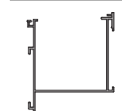

SG 8935

Profile



SG 8936

Profile

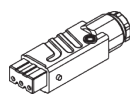

SG 9917

Hirschmann portable socket-outlet
STAK 3 N



SG 11095

Motor 230V AC, JA 04/35 comfort

B. OPTIONAL PARTS

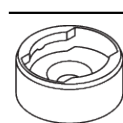

SG 8235

Side guide wire base short



SG 8236

Side guide wire base long

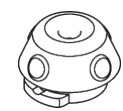

SG 8237

Side guide wire holder

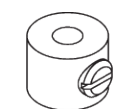

SG 8249

Side guide device

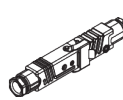

SG 9916

Hirschmann plug set

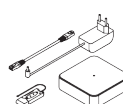

SG 9960

Move server set

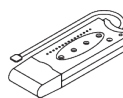

SG 9961

Move transmitter



SG 10120

Side guide wire \varnothing 0.9 mm



SG 10300

Radio hand held 1 channel



SG 10302

Radio hand held 5+1 channel

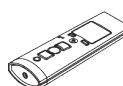

SG 10303

Radio hand held 10+2+1 channel

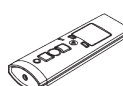

SG 10804

Radio hand held 15+5+1 channel

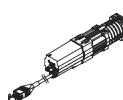

SG 11096

Motor 230V AC, JA 04/35
comfort, radio receiver

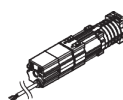

SG 11328

Motor 120V AC, JA 08/30 soft, UL

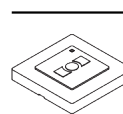

SG 11480

Radio wall transmitter 1 channel



SG 11490

Radio wall transmitter 5+1 channel

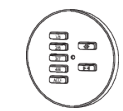

SG 20336

Hand held transmitter 8 channel

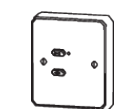

SG 20913

Wall switch single channel



SG 20914

Wall switch 8 channel

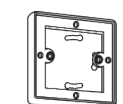

SG 20917

Pattress box

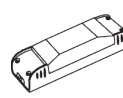

SG 20919

Control module motor type R